



IRRIGATION

SECTION 16



PRODUCT LINE	PAGE
Couplings.	16.032
Check Valves.	16.033A-D,16.034,16.035-16.036
Catch basins & Grates.	16.038-16.041A
Direct Buy Splice.	16.020,16.021
Drainage Emitter & Drains.	16.048
Electrical Installation Accessories.	16.022-A
Flo-Well Storm Water Leaching System.	16.037-A
Funny Pipe, Marlex Fittings, Swivel fitting.	16.017,16.047
Irrigation Installation Accessories.	16.011-16.012A-D,16.014
K-Rain Rotors, Sprays, Nozzles.	16.001,16.002A-P
K-Rain Controllers.	16.004A-D,16.007,16.009-A,16.010
K-Rain Solenoid Valves.	16.003A-B
Pinch Clamps.	16.025
Pump Start Relay.	16.005,16.023,16.024
Repair Fitting.	16.026,16.028-16.031
Saddle Tees.	16.013,16.015,16.016,16.018
Swing Joint Assemblies, Poly Swing Pipe.	16.019
Utility & Trash Pumps.	16.027





RPS75

RPS75™ Rotor

The RPS75™ gear drive is designed for basic residential and light commercial applications and is a direct replacement for Hunter® PGP® rotors. The reversing mechanism, a K-Rain patented feature, is the same mechanism used in the Hunter PGP (K-Rain currently licenses this patent to Hunter.) With K-Rain's wide selection of standard and low angle nozzles, the RPS75 provides even water distribution.

Features:

- Direct Replacement for Hunter® PGP®.
- Right Position Start - Rotor rotates counterclockwise from fixed right start position.
- Riser Fits in Existing Hunter PGP Cans - Simply unscrew the existing riser from the PGP can and replace with the RPS75 riser.
- Top Adjustment - No training necessary, the RPS75 has the same adjustment procedure as the Hunter PGP.
- Full and Part Circle Rotation - Provides a full range of adjustment from 40° to 360°
- Non-Flushing Wiper Seal - Reduces leaks caused by debris trapped under seal.
- 3/4" Inlet - Replaces all standard rotors.
- Ideal for Low Flow Applications.
- Universal Adjustment Tool - Compatible with existing Hunter products.
- Rubber Cover - Seals out dirt and increases product durability.
- Wide Selection of Nozzles - Including standard and low angle, provides flexibility in system design.
- **Key and check disc also included in master cases.**
- **FULL 5 YEAR WARRANTY.** Subject to all standard warranty conditions that apply to all K-Rain rotors.



ARC selection 40° - 360°. Adjusts from RIGHT start.



Find performance data on following page.

Specifications:

- Inlet 3/4" female threaded NPT
- Arc Adjustment Range: 40° to 360°
- Flow range: 0.75 - 8.2 GPM
- Pressure Rating: 30-70 PSI
- Precipitation Rate: 0.12 to 1.16 inches/hour
- Overall height popped down : 7 3/8"
- Recommended spacing: 25' to 45'
- Radius: 22' to 51'
- Nozzle trajectory: 25° standard or 11° low angle
- 8 standard and 4 low angle nozzles included
- Riser Height: 4"

Part Number	Description	Ctn Qty
RPS75	RPS Standard Rotor	20

K-Rain products are not available for sale in NC, SC, TN, or MA.



K-Rain® Rotors



RPS75™ Rotor Performance Data



STANDARD ANGLE

Nozzle	Pressure PSI	Radius Ft.	Flow Rate GPM
#0.75	30	29	0.7
	40	30	0.8
	50	30	0.9
	60	31	1.0
#1	30	30	0.9
	40	31	1.0
	50	31	1.2
	60	32	1.3
#1.5	30	32	1.2
	40	33	1.4
	50	34	1.6
	60	34	1.8
#2	30	34	1.6
	40	36	1.8
	50	38	2.0
	60	38	2.2
#3 preinstalled	30	36	2.0
	40	38	2.4
	50	40	2.7
	60	40	2.9
#4	30	36	2.6
	40	40	3.0
	50	42	3.4
	60	42	3.7
#6	30	38	4.2
	40	43	4.9
	50	46	5.5
	60	47	6.0
#8	40	45	6.0
	50	48	6.8
	60	49	7.6
	70	51	8.2

LOW ANGLE

#1	30	22	1.2
	40	24	1.7
	50	26	1.8
	60	28	2.0
#3	30	29	3.0
	40	32	3.1
	50	35	3.5
	60	37	3.8
#4	30	31	3.4
	40	34	3.9
	50	37	4.4
	60	38	4.7
#6	40	38	6.5
	50	40	7.3
	60	42	8.0
	70	44	8.6

Data represents test results in zero wind.

Adjust for local conditions.

Radius may be reduced with nozzle retention screw.

K-Rain products are not available for sale in NC, SC, TN, or MA.



www.cbsupplies.ca
 Phone: (866) 503-5523 Fax: (888) 562-2095
 AGI@cbsupplies.ca





RPS SELECT

RPS® SELECT Rotor

The RPS® SELECT rotary sprinkler is gear-driven for basic residential and light commercial applications. With 4 selectable built-in nozzles, matched precipitation is fast and easy without the need to change nozzles in the field.



Features:

- Four built-in selectable nozzles to match arc settings 90° to 360°
- Adjustable Arc (40° to 360°) made from the top with no special tools needed.
- Matched precipitation rate when nozzle setting matched to arc.
- 3/4" Inlet - Replaces all standard rotors.
- Low pressure operation.
- Standard Rubber Cover
- Proven gear-drive design common to the popular RPS75® series.
- Riser assembly interchanges with Hunter® PGP® rotors
- **Key and check disc also included in master cases.**
- **FULL 5 YEAR WARRANTY.** Subject to all standard warranty conditions that apply to all K-Rain rotors.

Specifications:

- Inlet 3/4" female threaded NPT
- Arc Adjustment Range: 40° to 360°
- Flow range: 1.3 - 6.8 GPM
- Pressure Rating: 30-70 PSI
- Precipitation Rate: 0.23 to 0.71 inches/hour
- Overall height popped down: 7 3/8"
- Recommended spacing: 31' to 44'
- Radius: 33' to 46'

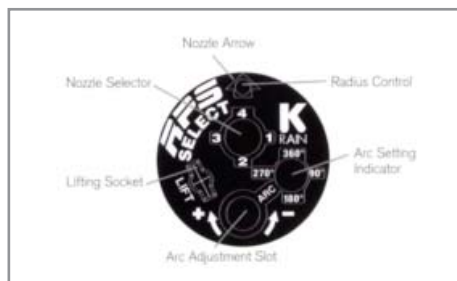

Nozzle	Pressure PSI	Radius Ft.	Flow Rate GPM
#1 90°	30	33	1.3
	35	34	1.4
	40	37	1.5
	45	37	1.6
	50	37	1.8
#2 180°	30	37	2.6
	35	38	2.8
	40	39	3.0
	45	40	3.2
	50	40	3.6
#3 270°	30	37	3.8
	35	40	4.1
	40	41	4.5
	45	41	4.7
	50	43	4.9
#4 360°	30	38	5.2
	35	40	5.7
	40	44	6.0
	45	45	6.4
	50	46	6.8

Part Number	Description	Ctn Qty
RPS SELECT	RPS Select Rotor	20

K-Rain products are not available for sale in NC, SC, TN, or MA.



13003

MiniPro™ Rotor

Perfect for small lawn and landscape areas and for replacing fixed sprays.
Direct replacement for the Toro Mini8.

Features:

- Gear driven, rotary type sprinkler capable of covering an area of 17' to 30'.
- Revolutionary patented easy arc set is easily adjusted from the top with a flat blade screwdriver. Stainless steel radius adjustment screw.
- Adjustable rotation provides a full range of adjustments from 40° to 360°. Patented arc set degree markings clearly indicate current watering pattern and simplifies adjustment
- Adjustable in all phases of installation - before, after while static or while in operation.
- Time proven patented reversing mechanism assures continuous reverse and return.
- Ratcheting riser easily adjusts your left start position by turning the riser.
- Supplied with 5 numerically coded interchangeable nozzles. Wide selection of nozzles provides flexibility in system design to achieve matched precipitation.
- Heavy duty rubber cover seals out dirt and increases durability.
- **FULL 5 YEAR WARRANTY. Subject to all standard warranty conditions that apply to all K-Rain rotors.**



Find performance data on following page.

Specifications:

- Inlet 1/2" NPT
- Arc adjustment range 40° to 360°
- Flow range: 0.75 - 3.3 GPM
- Pressure Rating: 20-70 PSI
- Precipitation Rate: 0.22 to 0.41 inches/hour (depending on spacing and nozzle used)
- Overall height popped down : 6"
- Recommended spacing: 17' to 28'
- Radius: 17' to 30'
- Nozzle trajectory: 26°
- Riser Height: 4", 6" or 12".



ARC selection 40° - 360°.
Adjusts from LEFT start.

Part Number	Description	Ctn Qty
13003	MiniPro short range rotor 4"	25
13006	MiniPro short range rotor 6"	20
13012	MiniPro short range rotor 12"	12

K-Rain products are not available for sale in NC, SC, TN, or MA.



www.cbsupplies.ca
Phone: (866) 503-5523 Fax: (888) 562-2095
AGI@cbsupplies.ca





MiniPro™ Rotor Performance Data

STANDARD ANGLE

Red Nozzle

Performance Data:			
Nozzle	Pressure PSI	Radius Ft.	Flow Rate GPM
#0.75	30	17'	.75
	40	17'	.8
	50	18'	.9
#1	30	20'	.9
	40	21'	1.2
	50	21'	1.3
#1.5 preinstalled	30	23'	1.4
	40	24'	1.7
	50	24'	1.9
#2	30	25'	1.8
	40	27'	2.1
	50	27'	2.4
#3	30	28'	2.7
	40	30'	3.0
	50	30'	3.3

K-Rain products are not available for sale in NC, SC, TN, or MA.



www.cbsupplies.ca
 Phone: (866) 503-5523 Fax: (888) 562-2095
AGI@cbsupplies.ca





11003

ProPlus™ 11003 Rotor

Appropriate for medium to large landscape areas with high level risers and shrubs.

Direct replacement for the Toro Super800.

Features:

- Gear driven, rotary type sprinkler capable of covering an area of 22' to 50'.
- Revolutionary patented easy arc set is easily adjusted from the top with a flat blade screwdriver. Stainless steel radius adjustment screw.
- 2N1 adjustable or continuous rotation provides a full range of adjustments from 40° to a full 360°. Patented arc set degree markings show the degree of adjustment with the point of an arrow on the top cover.
- Arc memory clutch returns rotor to its preset position automatically even after being tampered with. Time proven patented reversing mechanism assures continuous reverse and return.
- Ratcheting riser easily adjusts your left start position by turning the riser.
- Supplied with 9 numerically coded interchangeable nozzles including 4 low angle nozzles. Wide selection of nozzles provides flexibility in system design to achieve matched precipitation.
- Heavy duty rubber cover seals our dirt and increases durability.
- **FULL 5 YEAR WARRANTY. Subject to all standard warranty conditions that apply to all K-Rain rotors.**



Specifications:

- Inlet 3/4" threaded NPT
- Arc Adjustment Range: 40° to continuous 360°
- Flow range: 0.5 - 10.0 GPM
- Pressure Rating: 20-70 PSI
- Precipitation Rate: 0.06 to 0.50 inches/hour (depending on spacing and nozzle used)
- Overall height popped down : 7 1/2"
 - 17" for High pop
- Recommended spacing: 28' to 44'
- Radius: 22' to 50'
- Nozzle trajectory: 26° standard or 12° low angle
- Riser Height: 5"



ARC selection 40° to continuous 360°. Adjusts from LEFT start.

Find performance data on following page.

Part Number	Description	Ctn Qty
11003	ProPlus mid-range rotor	20

K-Rain products are not available for sale in NC, SC, TN, or MA.





ProPlus™ 11003 Rotor Performance Data

STANDARD ANGLE

Red Nozzle

Nozzle	Pressure PSI	Radius Ft.	Flow Rate GPM	
#0.5	30	28	0.5	
	40	29	0.6	
	50	29	0.7	
	60	30	0.8	
#0.75	30	29	0.7	
	40	30	0.8	
	50	31	0.9	
	60	32	1.0	
#1	30	32	1.3	
	40	33	1.5	
	50	34	1.6	
	60	35	1.8	
#2	30	37	2.4	
	40	40	2.5	
	50	42	3.0	
	60	43	3.3	
#2.5	30	38	2.5	
	preinstalled	40	39	2.8
	50	40	3.2	
	60	41	3.5	
#3	30	38	3.6	
	40	39	4.2	
	50	41	4.6	
	60	42	5.0	
#4	30	43	4.4	
	40	44	5.1	
	50	46	5.6	
	60	49	5.9	
#6	40	45	5.9	
	50	46	6.0	
	60	48	6.3	
	70	49	6.7	
#8	40	42	8.0	
	50	45	8.5	
	60	49	9.5	
	70	50	10.0	

LOW ANGLE

Green Nozzle

Nozzle	Pressure PSI	Radius Ft.	Flow Rate GPM
#1	30	22	1.2
	40	24	1.7
	50	26	1.8
	60	28	2.0
#3	30	29	3.0
	40	32	3.1
	50	35	3.5
	60	37	3.8
#4	30	31	3.4
	40	34	3.9
	50	37	4.4
	60	38	4.7
#6	40	38	6.5
	50	40	7.3
	60	42	8.0
	70	44	8.6

K-Rain products are not available for sale in NC, SC, TN, or MA.





10003

SuperPro™ 10003 Rotor

With flow control, appropriate for residential or light commercial.
Direct replacement for the Toro Super 800.



Features:

- Riser fits in existing Toro Super800 cans.
- Gear driven, rotary type sprinkler capable of covering an area of 26' to 49'.
- Patented flow control valve inside the rotor allows individual head to be turned off or be partially closed to reduce the distance by up to 75%. Additionally it simultaneously reduces the flow rate creating an added water savings.
- Revolutionary patented easy arc set is easily adjusted from the top with a flat blade screwdriver. Stainless steel radius adjustment screw.
- 2N1 adjustable or continuous rotation provides a full range of adjustments from 40° to continuous 360°. Patented arc set degree markings show the degree of adjustment with the point of an arrow on the top cover.
- Arc memory clutch returns rotor to its preset position automatically even after being tampered with. Time proven patented reversing mechanism assures continuous reverse and return.
- Ratcheting riser easily adjusts your left start position by turning the riser.
- Supplied with 9 numerically coded interchangeable nozzles including 4 low angle nozzles.
- Heavy duty rubber cover seals out dirt and increases durability.
- 5 year limited warranty.



Specifications:

- Inlet 3/4" threaded NPT
- Arc Adjustment Range: 40° to continuous 360°
- Flow range: 0.5 - 10.0 GPM
- Pressure Rating: 20-70 PSI
- Precipitation Rate: 0.05 to 0.74 inches/hour (depending on spacing and nozzle used)
- Overall height popped down : 7 1/2"
- Recommended spacing: 28' to 44'
- Radius: 26' to 49'
- Nozzle trajectory: 26° standard or 12° low angle
- Riser Height: 5"

Part Number	Description	Ctn Qty
10003	SuperPro rotor	20



ARC selection 40° to continuous 360°. Adjusts from LEFT start.

Find performance data on following page.

K-Rain products are not available for sale in NC, SC, TN, or MA.



www.cbsupplies.ca
Phone: (866) 503-5523 Fax: (888) 562-2095
AGI@cbsupplies.ca





SuperPro™ 10003 Rotor Performance Data

STANDARD ANGLE

Nozzle	Pressure PSI	Radius Ft.	Flow Rate GPM	
#0.5	30	30	0.45	
	40	29	0.5	
	50	26	0.6	
	60	26	0.7	
#0.75	30	32	0.7	
	40	32	0.8	
	50	33	0.9	
	60	33	1.0	
#1	30	30	1.1	
	40	32	1.3	
	50	33	1.5	
	60	33	1.6	
#2	30	38	2.3	
	40	38	2.5	
	50	40	2.7	
	60	42	3.0	
#2.5	30	35	2.5	
	preinstalled	40	36	2.8
	50	37	3.2	
	60	38	3.6	
#3	30	35	3.4	
	40	36	3.8	
	50	38	4.2	
	60	39	4.8	
#4	30	42	4.1	
	40	44	4.6	
	50	45	5.1	
	60	46	5.7	
#6	40	46	5.8	
	50	48	6.4	
	60	49	7.0	
	70	49	7.5	
#8	40	42	7.5	
	50	45	8.2	
	60	48	9.0	
	70	48	9.5	

LOW ANGLE

Nozzle	Pressure PSI	Radius Ft.	Flow Rate GPM
#1	30	26	1.3
	40	27	1.5
	50	27	1.7
	60	28	1.9
	#3	30	29
#3	40	30	3.3
	50	31	3.4
	60	33	4.0
	#4	30	28
#4	40	31	4.7
	50	34	5.0
	60	36	6.0
	#6	40	30
#6	50	34	7.0
	60	37	7.8
	70	38	8.2

K-Rain products are not available for sale in NC, SC, TN, or MA.





K Spray Series

K-Spray Series Spray Bodies

Ideal for watering smaller areas, ground cover and shrub areas.

Features:

- Available in 3", 4" 6" and 12" models which provide flexibility in design.
- Accepts MALE threaded nozzles.
- Stainless steel retraction spring provides reliable retraction of the riser in all soil conditions.
- Ratchet riser allows for easy pattern alignment by turning the riser.
- Heavy duty wiper seal ensures leak free, full pop-up operation even under low pressure situations.



Specifications:

- Inlet 1/2" NPT female thread
- Flow range: 0.5 - 4.6 GPM
- Pressure Rating: 20-50 PSI
- Precipitation Rate: 0.4 to 1.91 inches/hour

Part Number	Description	Ctn Qty
73001	3" Pop-up Spray body (less nozzles)	100
74001	4" Pop-up Spray body (less nozzles)	50
76001	6" Pop-up Spray body (less nozzles)	50
71201	12" Pop-up Spray body (less nozzles)	25

K-Rain products are not available for sale in NC, SC, TN, or MA.



PRO-S Spray

Pro-S Pop-Up Sprays

A rugged, contractor friendly spray line designed to be compatible with ALL standard female threaded nozzles.

Direct replacement for RainBird® 1800 Series sprays.

Features:

- Available in 2", 3", 4" 6" and 12" models which provide flexibility in design.
- **Accepts FEMALE threaded nozzles.**
- Co-Molded wiper seal ensures a leak free, full pop up operation under low pressure situations. Cartridge design allows for easy removal and cleaning. Treated with UV inhibitors for long life. Seal is microbe resistant to reduce degradation and stick ups.
- Ratcheting riser allows for easy pattern alignment by turning the riser.
- Heavy duty retraction spring for positive retraction in all soil conditions.
- Side and bottom inlet on 6" and 12" models.
- Pre-installed flush cap.
- 5 year Limited Warranty.



Specifications:

- Inlet 1/2" NPT Female Thread
- Flo range: 0 @ 8 psi, 0.10 gpm
- Pressure Rating: 20-70 psi
- Precipitation Rate: 0.4-4 inches/hour
- Overall Body Height: 2" pop up - 4"
3" pop up - 4 7/8"
4" pop up - 6"
6" pop up - 9 3/8"
12" pop up - 16"



Co-molded wiper seal

Part Number	Description	Ctn Qty
78002	2" Pop up spray	50
78003	3" Pop up spray	50
78004	4" Pop up spray	50
78004-PR	4" Pop up spray w/ pressure regulator	50
78006	6" Pop up spray	50
78006-PR	6" Pop up spray w/ pressure regulator	50
78012	12" Pop up spray	25
78012-PR	12" Pop up spray w/ pressure regulator	50
P53428	ProS Spray Check Disk	25

K-Rain products are not available for sale in NC, SC, TN, or MA.



RN Rotary Nozzle

Fixed Pattern Rotary Nozzle

Provides increased uniform coverage over conventional fixed spray nozzles while delivering matched precipitation.

Features:

- Perfect for upgrading old irrigation systems by solving low pressure and coverage problems.
- Matched precipitation across various radii and patterns.
- Low precipitation rate reduces run off.
- Low flow rate means less material and fewer zones.
- 25% radius reduction for patented flow control, no tools required.
- Unique speed control maintains the speed of rotation over varying pressure ranges.
- Any pattern can be combined in the same zone with matched precipitation.
- Larger filter prolongs product life.
- 2 year Limited Warranty.



Specifications:



- Spacing: 13-17 ft
- Pressure Rating: 20-45 psi
- Precipitation Rate: 0.67 - 0.99 inches/hour depending on head spacing.



Part Number	Description	Color	Ctn Qty
RN100-ADJ	Rotary Nozzle - Adjustable 80-360° 10-17'		10
RN200-ADJ	Rotary Nozzle - Adjustable 80-360° 17-21'		10
RN300-ADJ	Rotary Nozzle - Adjustable 80-360° 21-26'		10



FIXED PATTERN ROTARY NOZZLES - PERFORMANCE SPECS

Part Number	Nozzle Pattern	Pressure PSI	Radius Ft.	Flow Rate GPM	Flow GPH	Precip	Precip
 RN200-90	90°	25	13	0.38		0.99	0.86
		30	14	0.41		0.93	0.81
		35	15	0.45		0.89	0.77
		40	16	0.48		0.84	0.72
		45	17	0.51		0.78	0.68
 RN200-180	180°	25	13	0.74		0.97	0.84
		30	14	0.81		0.92	0.80
		35	15	0.90		0.89	0.77
		40	16	0.96		0.83	0.72
		45	17	1.00		0.77	0.67
 RN200-360	270°	25	13	1.50		0.99	0.85
		30	14	1.70		0.96	0.83
		35	15	1.80		0.89	0.77
		40	16	2.00		0.87	0.75
		45	17	2.10		0.81	0.70

K-Rain products are not available for sale in NC, SC, TN, or MA.



KV Nozzles

KV Variable Arc Nozzles

KV adjustable nozzles have a MALE thread configuration to fit K-Spray bodies.

Features:

- Superior spray pattern ensures proper precipitation rates throughout the adjustment.
- Color coded by distance.
- Extra long filters provide longer time between cleaning.



Find performance data on following page.

Part Number	Description	Color	Ctn Qty
KV8	8' Variable arc nozzle male thread	Green	25
KV10	10' Variable arc nozzle male thread	Blue	25
KV12	12' Variable arc nozzle male thread	Brown	25
KV15	15' Variable arc nozzle male thread	Black	25
KV17	17' Variable arc nozzle male thread	Gray	25



KVF Nozzles

KVF Variable Arc Nozzles

KVF adjustable nozzles have a FEMALE thread configuration to fit RPS and PRO-S spray bodies.

Features:

- Superior spray pattern ensures proper precipitation rates throughout the adjustment.
- Color coded by distance.
- Extra long filters provide longer time between cleaning.

Find performance data on following page.

Part Number	Description	Color	Ctn Qty
KVF8	8' Variable arc nozzle female thread	Green	25
KVF10	10' Variable arc nozzle female thread	Blue	25
KVF12	12' Variable arc nozzle female thread	Brown	25
KVF15	15' Variable arc nozzle female thread	Black	25

K-Rain products are not available for sale in NC, SC, TN, or MA.



K-Rain® Nozzles



VARIABLE ARC NOZZLES - PERFORMANCE SPECS FOR KV NOZZLES



Arc	Pressure PSI	8' GREEN Radius Ft.	Flow GPM	10' BLUE Radius Ft.	Flow GPM	12' BROWN Radius Ft.	Flow GPM	15' BLACK Radius Ft.	Flow GPM	17' GRAY Radius Ft.	Flow GPM
90°	20	9	0.7	12	0.7	12	1.1	15	1.3	18	1.7
	30	9	1.1	12	1.1	13	1.3	17	1.6	18	1.8
	40	10	1.4	13	1.4	14	1.5	18	1.8	19	2.0
	50	11	1.5	14	1.5	15	1.7	19	2.0	20	2.2
180°	20	8	1.4	11	1.4	11	1.6	14	1.8	17	1.9
	30	8	1.6	11	1.6	12	1.8	15	2.3	18	2.4
	40	9	1.8	12	1.8	13	2.2	16	2.6	19	2.6
	50	10	2.0	13	2.0	14	2.4	18	2.8	19	2.6
270°	20	8	1.7	10	1.7	11	1.9	14	2.7	16	2.9
	30	8	2.0	10	2.0	12	2.4	15	3.2	17	3.4
	40	8	2.3	11	2.3	12	2.6	16	3.6	18	4.0
	50	9	2.6	12	2.6	13	3.0	16	4.0	18	4.0
360°	20	8	2.2	10	2.2	11	2.8	13	3.4	15	3.5
	30	8	2.7	10	2.7	12	3.1	15	4.2	17	4.4
	40	8	3.0	11	3.0	12	3.5	15	4.7	17	4.9
	50	8	3.5	12	3.5	13	3.9	16	5.3	18	5.4

VARIABLE ARC NOZZLES - PERFORMANCE SPECS FOR KVF NOZZLES



Arc	Pressure PSI	8' GREEN Radius Ft.	Flow GPM	10' BLUE Radius Ft.	Flow GPM	12' BROWN Radius Ft.	Flow GPM	15' BLACK Radius Ft.	Flow GPM	17' GRAY Radius Ft.	Flow GPM
90°	20	9	0.40	9	0.40	10	0.45	13	0.55	17	0.80
	25	9	0.42	9	0.42	11	0.52	14	0.63	18	0.94
	30	10	0.45	10	0.45	12	0.55	15	0.70	19	1.05
	40	10	0.50	10	0.50	12	0.60	16	0.80	19	1.30
180°	20	9	1.00	9	1.00	9	1.10	13	1.30	17	1.70
	25	9	1.10	9	1.10	10	1.21	14	1.49	17	1.92
	30	10	1.20	10	1.20	10	1.35	15	1.65	19	2.15
	40	10	1.25	10	1.25	11	1.53	16	2.00	19	2.50
270°	20	9	1.40	9	1.40	9	1.60	13	1.90	16	2.40
	25	10	1.59	10	1.59	10	1.74	15	2.15	16	2.82
	30	10	1.75	10	1.75	10	1.95	15	2.35	17	3.00
	40	10	2.05	10	2.05	11	2.05	16	2.70	18	3.50
360°	20	9	2.30	9	2.30	9	2.40	13	2.80	16	2.90
	25	10	2.51	10	2.51	10	2.61	14	3.26	17	3.40
	30	10	2.65	10	2.65	11	2.78	15	3.60	17	3.80
	40	11	2.75	11	2.75	12	3.03	15	4.10	17	4.40

K-Rain products are not available for sale in NC, SC, TN, or MI.



Fixed Nozzles

Fixed Pattern Female Nozzles

Matched precipitation female nozzles are compatible with ALL available male threaded bodies.

Features:

- Color coded for easy identification.
- Four distances plus eight fixed patterns provides an array of configurations.
- Matched precipitation allows for even water distribution.



Series Number	Description	Color	Ctn Qty
FN8 *	8' Fixed pattern female nozzle	Green	25
FN10 *	10' Fixed pattern female nozzle	Blue	25
FN12 *	12' Fixed pattern female nozzle	Brown	25
FN15 *	15' Fixed pattern female nozzle	Black	25

* Add nozzle pattern reference letter to complete part number.

Fixed Pattern FEMALE THREADED Nozzles Performance & Pricing

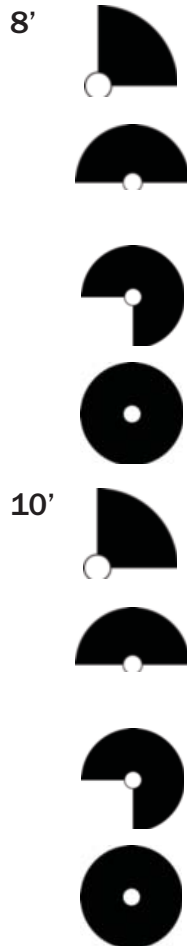

Pattern Letter*	Nozzle Pattern	Pressure PSI	Radius Ft.	Flow Rate GPM	Ctn Qty	Part Number
Q	90°	15	5	0.18	25	FN8Q
		20	6	0.21		
		25	7	0.24		
		30	8	0.26		
H	180°	15	5	0.37	25	FN8H
		20	6	0.41		
		25	7	0.47		
		30	8	0.52		
TQ	270°	15	5	0.55	25	FN8TQ
		20	6	0.63		
		25	7	0.71		
		30	8	0.78		
F	360°	15	5	0.74	25	FN8F
		20	6	0.86		
		25	7	0.95		
		30	8	1.05		
Q	90°	15	7	0.29	25	FN10Q
		20	8	0.33		
		25	9	0.36		
		30	10	0.39		
H	180°	15	7	0.58	25	FN10H
		20	8	0.65		
		25	9	0.72		
		30	10	0.79		
TQ	270°	15	7	0.87	25	FN10TQ
		20	8	0.98		
		25	9	1.08		
		30	10	1.18		
F	360°	15	7	1.16	25	FN10F
		20	8	1.30		
		25	9	1.44		
		30	10	1.58		

K-Rain products are not available for sale in NC, SC, TN, or MA.

K-Rain® Nozzles



Fixed Pattern THREADED Nozzles Performance & Pricing

	Pattern Letter*	Nozzle Pattern	MALE (P)			FEMALE (FN)			Ctn Qty	MALE/FEMALE Part No
			Pressure PSI	Radius Ft.	Flow Rate GPM	Pressure PSI	Radius Ft.	Flow Rate GPM		
12'	Q	90°	20	11	0.5	15	9	0.45	25	P12Q
			25	12	0.7	20	10	0.53		FN12Q
			40	13	0.8	25	11	0.60		
			50	14	0.9	30	12	0.65		
	H	180°	20	11	0.9	15	9	0.90	25	P12H
			25	12	1.1	20	10	1.05		FN12H
			40	13	1.4	25	11	1.20		
			50	14	1.5	30	12	1.30		
	TQ	270°	20	12	1.2	15	9	1.35	25	P12TQ
			25	12	1.4	20	10	1.58		FN12TQ
			40	14	1.7	25	11	1.80		
			50	15	2.0	30	12	1.95		
F	360°	20	10	1.6	15	9	1.80	25	P12F	
		25	12	1.8	20	10	2.10		FN12F	
		40	13	2.1	25	11	2.40			
		50	14	2.4	30	12	2.60			
15'	Q	90°	20	15	0.7	15	11	0.65	25	P15Q
			30	16	0.9	20	12	0.75		FN15Q
			40	17	1.1	25	14	0.82		
			50	18	1.2	30	15	0.92		
	H	180°	20	14	1.4	15	11	1.30	25	P15H
			30	15	1.7	20	12	1.50		FN15H
			40	16	2.0	25	14	1.65		
			50	17	2.2	30	15	1.85		
	TQ	270°	20	13	2.0	15	11	1.95	25	P15TQ
			30	15	2.5	20	12	2.25		FN15TQ
			40	16	2.9	25	14	2.48		
			50	16	3.2	30	15	2.78		
F	360°	20	13	2.9	15	11	2.60	25	P15F	
		30	15	3.6	20	12	3.00		FN15F	
		40	16	4.1	25	14	3.30			
		50	17	4.6	30	15	3.70			

Part Number	Description	Ctn Qty
PFRM	Filter for Fixed Nozzle	25

Special Pattern Nozzles Performance & Pricing

Pattern Letter*	Nozzle Pattern	Pressure PSI	Radius Ft.	Flow Rate GPM	Ctn Qty	MALE Part No	FEMALE Part No.
CS	CENTER	20	4' X 24'	0.8	25	P15CS	
	STRIP	30	4' X 30'	1.0			FN15CS
ES	END	20	4' X 12'	0.4	25	P15ES	
	STRIP	30	4' X 15'	0.5			FN15ES
SS	SIDE	20	4' X 28'	1.1	25	P15SS	
	STRIP	30	4' X 32'	1.3			FN15SS
HL	HIGH	20	H 14' X L4'X28'	2.5	25	P15HL	
	LOW	30	H 15' X L5'X32'	3.0			FN15HL

K-Rain products are not available for sale in NC, SC, TN, or MA.



www.cbsupplies.ca
 Phone: (866) 503-5523 Fax: (888) 562-2095
 AGI@cbsupplies.ca





K-Rain® Solenoid Valves



7001 Series



7001-NFC Series



7001-MXB Series

Designed for polyethylene piping systems, requires fewer fittings and can be installed quickly.



Flow Through

Self Cleaning Screen

Pro Series 100 Solenoid Valves

A contemporary tilt diaphragm makes this the perfect choice for residential, light commercial and dirty water applications.



Features:

- Heavy duty, corrosion & UV resistant PVC construction increases the life of the valve.
- Combination 1" and 1 1/4" connections provide the option to increase the pipe size to the valve increasing the flow rate.
- Tilted diaphragm/piston assembly allows for a straight flow path of the water increasing the flow rate while reducing the friction loss.
- Debris tolerant design provides flexibility for use in potable or dirty water applications.
- Manual external bleed through bleed screw allows for manual operation in system start-up.
- Manual internal bleed through solenoid allows for manual operation without leaking water.
- Flow control with removable handle allows for precise flow adjustment, manual shut-off and allows you to remove the handle to prevent tampering.
- Captured plunger solenoid allows for the solenoid to be removed without losing the plunger.
- Self cleaning metering screen is in the turbulent flow of water allowing self cleaning action during operation.
- 5 year Limited Warranty.

Specifications:

- Dimensions: 4" H x 3" W x 5 1/4" L
- Flow range: 0.75-35 GPM
- Pressure Rating: 20-150 PSI
- Pressure Loss @ 30 gpm - 5 psi
- Solenoid: 24 VAC 60 cycle
- Inrush Current: 0.43 Amps
- Holding Current: 0.25 Amps

Part Number	Description	Ctn Qty
7001	1" Female thread or 1 1/4" Male slip	12
7001-SL	1" Female slip or 1 1/4" Male slip	12
7001-NFC	1" Female th or 1 1/4" Male sl NO FLOW CONTROL	12
7001-SL-NFC	1" Female sl or 1 1/4" Male sl NO FLOW CONTROL	12
7001-MXB	1" Male x Barb	12
7001-MXB-NFC	1" Male x Barb NO FLOW CONTROL	12

K-Rain products are not available for sale in NC, SC, TN, or MA.



www.cbsupplies.ca
Phone: (866) 503-5523 Fax: (888) 562-2095
AGI@cbsupplies.ca



K-Rain® Solenoid Valves



7101 and 7101-J Series

Pro Series 150 1" Solenoid Valves

Offer the professional a wide array of features and benefits. Use for residential, light commercial, dirty water applications.



Features:

- Heavy duty, corrosion & UV resistant PVC construction increases the life of the valve.
- External bleed screw with removable metering pin allows for cleaning of the pin without disassembling the valve.
- **Threaded jar top** allows for quick removal of the cap for easy servicing. The glass filled nylon screw cap increases durability.
- **7101-J Series is direct replacement for Irritrol 2400.**
- Manual external bleed screw allows for manual operation in system start-up.
- Manual internal bleed through solenoid allows for manual operation without leaking water.
- Captured plunger solenoid allows for the solenoid to be removed without losing the plunger.
- 5 year Limited Warranty.

Specifications:

- Dimensions: 5 1/4" H x 3 1/8" W x 5" (without jar top)
5 1/4" H x 3" W x 4 3/8" Jar Top
- Flow range: 0.25-30 GPM
- Pressure Rating: 10-150 PSI
- Solenoid: 24 VAC 60 cycle
- Inrush Current: 0.4 Amps
- Holding Current: 0.2 Amps



No tools needed with Jar Top

Performance Data:

GPM	5	10	15	20	30
ProSeries 150 1" valve					
PSI LOSS	2.9	2.1	1.8	3.0	5.0
ProSeries 150 1" valve with jar top					
PSI LOSS	3.3	3.9	2.9	3.2	6.1

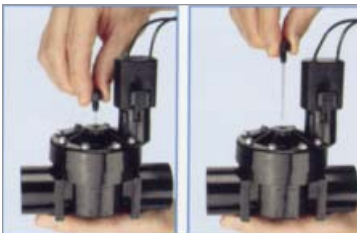

Manual External Bleed Screw

Part Number	Description	Ctn Qty
7101	1" Female thread NPT	12
7101-SL	1" Female Slip	12
7101-J	1" Female Thread Jar Top, NPT	12
7101-J-SL	1" Female Slip Jar Top	12

K-Rain products are not available for sale in NC, SC, TN, or MA.



www.cbsupplies.ca
 Phone: (866) 503-5523 Fax: (888) 562-2095
 AGI@cbsupplies.ca





K-Rain® Solenoid Valves



7102 and 7115 Series

Pro Series 150 1 1/2" and 2" Solenoid Valves

Feature a removable inlet cap to easily modify the configuration from globe to angle style.

Alternate to Irritrol 216b and 217b.



Features:

- Heavy duty, corrosion & UV resistant PVC construction increases the life of the valve.
- External bleed screw with removable metering pin allows for cleaning of the pin without disassembling the valve.
- Manual external bleed screw allows for manual operation in system start-up.
- Manual internal bleed through solenoid allows for manual operation without leaking water.
- Removable inlet cap allows for easy conversion from globe to angle style valve.
- Flow control allows for precise flow adjustment and manual shutoff.
- Captured plunger solenoid allows for the solenoid to be removed without losing the plunger.
- Heavy duty santoprene diaphragm design improves durability.
- 5 year Limited Warranty.



System Flexibility

Specifications:

- Dimensions: 1 1/2" valve: 8" H x 4 1/4" W x 5 1/2" L
2" valve: 8 7/8" H x 4 7/8" W x 6 1/3" L
- Flow range: 5-120 GPM
- Pressure Rating: 20-150 PSI
- Solenoid: 24 VAC 60 cycle
- Inrush Current: 0.4 Amps
- Holding Current: 0.2 Amps

Performance Data:

GPM		20	30	40	50	60	80	100	120
ProSeries 150 1 1/2" valve									
PSI LOSS	globe	3.0	2.6	2.3	2.9	4.1	5.5		
	angle	2.7	2.2	1.9	2.2	3.0	4.4		
ProSeries 150 2" valve									
PSI LOSS	globe	2.0	1.9	1.7	1.5	1.6	2.9	4.8	6.2
	angle	1.9	1.9	1.7	1.5	1.5	2.1	3.2	4.6

Part Number	Description	Ctn Qty
7115	1 1/2" Female Thread, NPT	6
7102	2" Female Thread, NPT	6

K-Rain products are not available for sale in NC, SC, TN, or MA.



www.cbsupplies.ca
 Phone: (866) 503-5523 Fax: (888) 562-2095
 AGI@cbsupplies.ca





RPS46 Series



RPS46 Controller

Designed for residential applications the RPS46 has four individual programs to allow for efficient watering on separate programs.

Features:

- 4 and 6 station models for residential lawns.
- 4 fully independent programs allowing up to 4 starts per program, maximum of 16 starts per day.
- Indoor models with external transformer and plug.
- Seasonal adjustment allows adjustment of watering durations from 25% to 150%.
- Rain sensor ready - accepts rain sensor signal and is controlled by a bypass switch.
- Flexible manual operations to run a program, station or test.
- Battery back-up holds programs during power outages.
- 2 year Limited Warranty.

Specifications:

- Dimensions: 5.7" H x 4.5" W x 1.7" D
- Station run times: 1 min - 12 hours 59 min.
- Programs: 4
- Start Times: 4 per program
- Water Schedules:
 - 7 day calendar w/ individual day selection
 - Odd/Even day or interval watering.
- Rain sensor ready inhibits automatic watering when wet conditions are detected by a rain sensor.
- Master valve / pump start signal.
- Automatic, semi-automatic and single station manual operation.

Electrical Specifications:

- Electrical Power Supply: 110-120 VAC/ 60 Hz/ 230 VAC 50 Hz.
- Electrical Outputs: 24 Volt AC, 0.85 amp.
- To Solenoid Valves: 24 VAC 50/60 Hz 0.5 amp max.
- Total output load must not be exceeded by the valves and pump requirements.
- Overload protection: Standard 20mm 1 amp fuse.
- Power failure: 9 volt standard alkaline battery maintains clock and programs for up to 2 weeks.
- Wiring: The output circuits should be installed and protected in accordance with wiring rules.

Part Number	Description	Ctn Qty
3504	4 station, 110 volt external transformer	1
3504-220	4 station, 220 volt external transformer	1
3506	6 station, 110 volt external transformer	1
3506-220	6 station, 220 volt external transformer	1

K-Rain products are not available for sale in NC, SC, TN, or MA.



K-Rain® Controllers



RPS469 Series

RPS469 Mid-Sized Controller

Designed for residential and light commercial applications the RPS469 has six individual programs to allow for efficient watering on separate programs.



Features:

- 4, 6 and 9 station models for residential and light commercial lawns.
- 6 fully independent programs allowing up to 6 starts per program, maximum of 36 starts per day.
- Indoor/Outdoor.
- Water conservation allows for quick adjustment of watering durations in 10% increments, from 10% to 200.
- Rain sensor ready - accepts rain sensors and allows individual stations to be set and controlled by the sensor.
- Flexible manual operations to run a program, station or test.
- System test allows for a full system check for valve operation.
- Battery back-up holds programs during power outages.
- Weatherproof enclosure ensures long product life.
- 2 year Limited Warranty.

Specifications:

- Dimensions: 8.8" H x 7.9" W x 2.9" D
- Station run times: 1 min - 12 hours 59 min.
- Programs: 6
- Start Times: 6 per program
- Water Schedules:
 - 7 day calendar w/ individual day selection or 1-15 day interval watering, or 365 day calendar for Odd/Even day watering.
- Rain sensor ready inhibits automatic watering when wet conditions are detected by a rain sensor.
- Master valve / pump can be enabled or disabled by station or program.
- Automatic, semi-automatic and single station manual operation.
- Capable of programming remotely using a standard 9 volt battery. Permanent memory saves all programs during power outages.

Electrical Specifications:

- Electrical Power Supply: 110-120 VAC/ 60 Hz/ 230 VAC 50 Hz.
- Electrical Outputs: 24 VOLT AC, 1 amp.
- To Solenoid Valve: 24 VAC 50/60 Hz 0.75 amp max.
- Total output load must not be exceeded by the valves and pump requirements.
- Overload protection: Standard 20mm 1 amp fuse.
- Power failure: 9 volt standard alkaline battery permanently maintains clock and programs. Has permanent memory so the data is always backed up during power outages.
- Wiring: The output circuits should be installed and protected in accordance with wiring rules.

Part Number	Description	Ctn Qty
3604	4 station, 110 volt internal transformer	1
3604-220	4 station, 220 volt internal transformer	1
3606	6 station, 110 volt internal transformer	1
3609	9 station, 110 volt internal transformer	1

K-Rain products are not available for sale in NC, SC, TN, or MA.



www.cbsupplies.ca
 Phone: (866) 503-5523 Fax: (888) 562-2095
 AGI@cbsupplies.ca



K-Rain® Controllers



PRO EX Series

PRO EX Modular Controller

Modular irrigation controller with easy expansion.



Features:

- Hot swappable 4 station modules allow controller upgrades from 4 to 16 station while in operation.
- 3 fully independent programs with up to 4 starts per program.
- Dual voltage transformer enables either 120VAC or 240 VAC.
- Program display on a large backlit LCD screen with watering days, number of start times, stations and AM/PM or 24 hr time format options.
- Flexible manual operations - automatic, semi-automatic and single station with manual start at the push of a button.
- System test allows for a full system check for valve operation.
- Permanent memory saves programs during power outages.
- Remote programming using 9V battery and wireless module connector features.
- Wire management is made easy with verticle station terminal strips.
- Diagnostic circuit breaker to identify wiring problems with visual and/or audible alerts for errors.
- Locate feature aids in locating buried valves.
- Station delay/overlap permits additional time between stations to allow for everyday hydraulic issues.
- Rain sensor ready - accepts rain sensors and allows programming of individual stations to be controlled by the sensor.
- Sensor bypass switch for global override.
- Master valve/pump start relay permits individual station programming.
- Dedicated Sensor and VT Valve Test Terminal enables direct sensor installation and matches field wires with station.
- Default programming saves and recalls programs.
- Permanent day off watering feature.
- Seasonal adjust water conservation allows for quick adjustment of watering times from 10-200%.

Specifications:

- Dimensions: 7.875" H x 11.5" W x 5.25" D
- Station run times: 1 sec - 6 hours for all stations
- Programs: 3
- Automatic Start Times: 4 per program
- Program Water Schedule:
 - Custom (day of the week)
 - Interval (1-31 days)
 - Odd or Even (calendar days)

Electrical Specifications:

- Power Input: 120 VAC +/- 10% 60 Hz
230 VAC +/- 10% 50 Hz
- Power Output: 24 VAC, 1.25 amp.
- Power Backup: Lithium coin-cell batters maintains time and date during primary power outages while the 9V battery allows remote programming and LCD viewing.
- Multi-Valve Operation: Up to three 24VAC, 7VA solenoid valves.

Limited Quantites. Available while supplies last.

Part Number	Description	Ctn Qty
3200	Base 4 Station Controller 120/240 VAC internal transformer	1
3204	4 Station Expansion Module	1

K-Rain products are not available for sale in NC, SC, TN, or MA.



www.cbsupplies.ca
 Phone: (866) 503-5523 Fax: (888) 562-2095
 AGI@cbsupplies.ca





K-Rain® Controllers



RPS1224 Series

RPS1224 Controller

Designed for residential and light commercial applications the RPS1224 covers all your needs regardless of the size or complexity of the project.



Features:

- 12, 18 and 24 station models for residential and light commercial applications.
- 8 fully independent programs allowing up to 8 starts per program, maximum of 64 starts per day.
- Indoor/Outdoor.
- Water conservation allows for quick adjustment of watering durations in 10% increments, from 10% to 200.
- Rain sensor ready - accepts rain sensors and allows individual stations to be set and controlled by the sensor.
- Flexible manual operations - automatic, semi-automatic and single station manual.
- System test allows for a full system check for valve operation.
- Permanent memory saves programs during power outages.
- Weatherproof enclosure ensures long product life.
- 2 year Limited Warranty.

Specifications:

- Dimensions: 9 3/8" H x 10 1/4" W x 4 1/8" D
- Station run times: 1 min - 12 hours 59 min.
- Programs: 8
- Start Times: 8 per program
- Water Schedule:
 - 7 day calendar w/ individual day selection or 1-15 day interval watering, or 365 day calendar for Odd/Even day watering.
- Rain sensor ready inhibits automatic watering when wet conditions are detected by a rain sensor.
- Two master valve / pump can be enabled or disabled by station or program.
- Automatic, semi-automatic and single station manual operation.
- Capable of programming remotely using a standard 9 volt battery. Permanent memory saves all programs during power outages.

Electrical Specifications:

- Electrical Power Supply: 110-120 VAC/ 60 Hz/ 230 VAC 50 Hz.
- Electrical Outputs: 24 Volt AC, 1.25 amp.
- To Solenoid Valve: 24 VAC 50/60 Hz 0.75 amp max.
- Total output load must not be exceeded by the valves and pump requirements.
- Overload protection: Standard 20mm 1 amp fuse.
- Power failure: 9 volt standard alkaline battery permanently maintains clock and programs. Has permanent memory so the data is always backed up during power outages.
- Wiring: The output circuits should be installed and protected in accordance with wiring rules.

Part Number	Description	Ctn Qty
3712	12 station, 110 volt internal transformer	1
3718	18 station, 110 volt internal transformer	1

K-Rain products are not available for sale in NC, SC, TN, or MA.



www.cbsupplies.ca
 Phone: (866) 503-5523 Fax: (888) 562-2095
 AGI@cbsupplies.ca



K-Rain® Controllers



2000 Series

2000 Series Single Station Controller

Single station controllers stay safe with rain-tight enclosures.



Features:

- 24 hour programmable time dial with multiple start times and a wide variety of timing periods including skip-a-day 14 day program.
- UL approved components.
- Perfect for nursery or mist applications.
- 2200 models have 10 minute programmable dial with a wide variety of timing periods in multiples of 1.5, 3 and 6 seconds and multiple start times.
- 2500 models are prewired for easy connection of a rainswitch and allows manual override of rainswitch from controller face.
- 2520 model allows operation of 24 volt rainswitch and 2 hp 220 volt pump with same controller.
- 2 year Limited Warranty.

Part Number	Voltage Input	Voltage Output	Rating	Ctn Qty
2100 Single Station Controllers				
2110	110 VAC, 60 Hz	110 VAC, 60 Hz	Single Pole, up to 1 HP	6
2112	110 VAC, 60 Hz	110 VAC, 60 Hz	Double Pole, up to 2 HP	6
2114	110 VAC, 60 Hz	24 VAC, 30 VA	Built in Transformer	6
2120	220 VAC, 60 Hz	220 VAC, 60 Hz	Double Pole, up to 2 HP	6
2200 Short Duration Single Station Controllers				
2210	110 VAC, 60 Hz	110 VAC, 60 Hz	up to 1 HP	6
2214	110 VAC, 60 Hz	24 VAC, 30 VA	Built in transformer	6
2500 Rainswitch Ready Controllers				
2510	110 VAC, 60 Hz	110 VAC, 60 Hz	Double Pole, up to 2 HP	6
2514	110 VAC, 60 Hz	24 VAC, 30 VA	Built in transformer	6
2520	220 VAC, 60 Hz	220 VAC, 60 Hz	Double Pole, up to 2 HP	6

K-Rain products are not available for sale in NC, SC, TN, or MA.



www.cbsupplies.ca
 Phone: (866) 503-5523 Fax: (888) 562-2095
 AGI@cbsupplies.ca





K-Rain® Pump Start Relays



1500 Series

1500 Series Pump Start Relays

Features:

- Industrial, rain tight, secure, rustproof industrial grade enclosure ensures long product life and deters tampering. UV resistant and shockproof.
- UL approved components.
- Large easy access enclosure provides easy accessibility during wiring.
- Enclosure has 8 recessed knock-outs to provide easy connections from any direction.
- 24 or 110 VAC coils for applications up to 10 hp.
- 4 plastic inset cover screws provide extra system security reduces liability and deters tampering.
- 2 year Limited Warranty.



Specifications:

- Dimensions: 7" H x 5" W x 4 5/8" D
- 24 VAC, 60 Hz or 110 VAC, 60 Hz
- Double pole, single throw

	Model #1522	Model #1521	Model #1552	Model #1551
• Inrush:	35 VA	42 VA	60 VA	77 VA
• Sealed:	7.0 VA, 3 watts	8.5 VA, 3.6 watts	7 VA, 2.3 watts	10 VA, 4 watts
• Resistance (+10%):	11 ohms	210 ohms	5.61 ohms	89.5 ohms
• Inductive:	20 amp	20 amp	40 amp	40 amp
• Resistive:	30 amp	30 amp	50 amp	50 amp
• Input 120 V:	up to 3 hp	up to 3 hp	up to 3 hp	up to 3 hp
• Input 240 V:	up to 3 hp	up to 3 hp	up to 5 hp	up to 5 hp



Part Number	Description	Volts	Ctn Qty
1522	3 hp pump start relay	24 VAC	8
1521	3 hp pump start relay	110 VAC	8
1552	5 hp pump start relay	24 VAC	8
1551	5 hp pump start relay	110 VAC	8

K-Rain products are not available for sale in NC, SC, TN, or MA.



www.cbsupplies.ca
 Phone: (866) 503-5523 Fax: (888) 562-2095
 AGI@cbsupplies.ca







K-Rain® Rain Sensor



3208

3208 Rain Sensor Features:

- Turns irrigation controllers into water managers by suspending watering during rain and/or freeze periods.
- Weather resistant. Made of UV resistant polymer for outdoor exposure.
- Maintenance free. No batteries to replace.
- 2 in 1 mounting provides flexible installation with standard flat and gutter mounting.
- HRFS includes a freeze sensor that prevents the system from starting when temperatures drop to 37° F or below.



Part Number	Description
3208-HRS	Hardwired Rain Sensor
3208-HRFS	Hardwired Rain/Freeze Sensor





K-Rain® Indexing Valves



4000 Series



4000 Series Indexing Valves

Features:

- Automates multiple zoned residential and small commercial irrigations systems.
- Ideally suited for both city water and pump applications.
- ABS Polymer body construction is high strength, non-corrosive for long product life.
- Available in 4 and 6 outlet models to easily change from two to six watering zones.
- Operates at low 10 gpm at pressures of 25-75 psi.
- Simplicity of design and few moving parts ensures easy maintenance and long life.
- 2 year Limited Warranty.

Specifications:

- ABS polymer construction
- Dimensions: 5 3/4" H x 5 3/4" W
- Flow Range: 10-40 gpm
- Pressure rating: 25-75 psi
- Pressure Loss

4 outlet valve	Flow gpm	10	20	30	40
	PSI loss	2.0	3.0	4.5	6.4
6 outlet valve	Flow gpm	10	20	30	
	PSI loss	2.5	4.5	7.5	

Part Number	Description	Zones	Ctn Qty
4400	4 outlet index valve	NO cam	8
4402	4 outlet index valve	2 zones	8
4403	4 outlet index valve	3 zones	8
4404	4 outlet index valve	4 zones	8
P6107042	2 zone cam only		5
P6107043	3 zone cam only		5
P6107044	4 zone cam only		5
4600	6 outlet index valve	NO cam	8
4602	6 outlet index valve	2 zones	8
4603	6 outlet index valve	3 zones	8
4604	6 outlet index valve	4 zones	8
4605	6 outlet index valve	5 zones	8
4606	6 outlet index valve	6 zones	8
P6107063	3 zone cam only		5
P6107064	4 zone cam only		5
P6107065	5 zone cam only		5
P6107066	6 zone cam only		5
P6200400	Cam screws - set of 2 per bag		5

K-Rain products are not available for sale in NC, SC, TN, or MA.



www.cbsupplies.ca
 Phone: (866) 503-5523 Fax: (888) 562-2095
 AGI@cbsupplies.ca



K-Rain® Indexing Valves



KR6000 Series

KR6000 Series Indexing Valves

Features:

- Automates multiple zoned residential and small commercial irrigations systems with high pressure.
- Recommended for pump fed or high-flow city water systems.
- Metal die-cast body is durable, long lasting and capable of high pressure applications.
- Available in 4 and 6 outlet models to easily change from two to six watering zones.
- Operates at 15 gpm at pressures of 25-150 psi.
- Built-in atmospheric vacuum breaker releases any vacuum created between the pump and valve on shut down.
- 2 year Limited Warranty.



Specifications:

- Die-cast metal valve top/housing, ABS polymer outlets.
- Dimensions: 7" H x 8" W
- Inlet: 1 1/2" threaded NPT connection
- Outlet: Slip and glue connections to 1 1/2" PVC pipe
- Flow Range: 15-150 gpm
- Pressure rating: 25-150 psi
- Pressure Loss

4 outlet valve	Flow gpm	20	40	60	80	100
	PSI loss	2.5	3.5	5.0	7.5	10.0
6 outlet valve	Flow gpm	20	40	60	80	100
	PSI loss	3.0	4.0	6.0	9.0	11.0

Part Number	Description	Zones	Ctn Qty
KR6402	4 outlet index valve	2 zones	4
KR6403	4 outlet index valve	3 zones	4
KR6404	4 outlet index valve	4 zones	4
KR6605	6 outlet index valve	5 zones	4
KR6606	6 outlet index valve	6 zones	4

K-Rain products are not available for sale in NC, SC, TN, or MA.

wired anywhere along the common wire line.

B. 24-VAC Solenoid Valve WITH Pump Start Relay (Figure 3)

Locate the common wire to the solenoid valves and the common wire lead to the coil of the relay that starts the pump. If these two wires are connected to the “common” terminal on the controller, disconnect both of them. Twist these two wires together along with one wire from the rain sensor and secure with a wire nut. Attach the other wire of the rain sensor to the “common” terminal on the controller.

Check to verify correct wiring:

Turn on one zone of the sprinkler system that is visible while you are in reach of the rain sensor. Manually depress the spindle at the top of the rain sensor until you hear the switch click off. The sprinkler zone should stop instantly. If it does not, check wiring for correct installation.

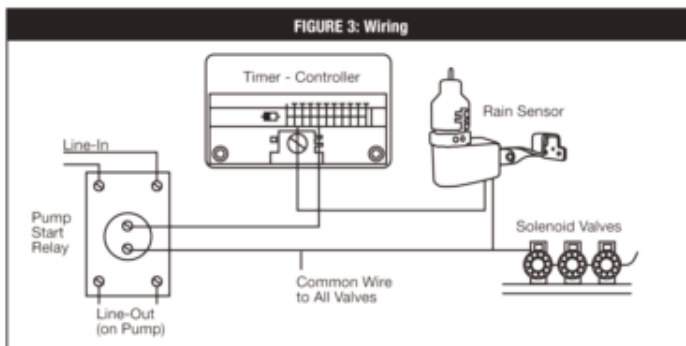

ADJUSTMENTS and OPERATION

The rain sensor can keep the irrigation system from starting or continuing after rainfall quantities of 1/8", 1/4", 1/2", 3/4" or 1". To adjust it to the desired quantity of rainfall, rotate the cap on the switch housing so that the pins are located in the proper slots. (Figure 4) Do not forcibly twist the cap as this might break the pins. The time that it takes the rain sensor to reset for normal sprinkler operation after the rain has stopped is determined by weather conditions (wind, sunlight, humidity). These conditions will determine how fast the hygroscopic discs will dry out, and since the landscape will also be experiencing the same conditions, the irrespective drying rates will roughly parallel each other. Note that there is an adjustment capability on the rain sensor that will slow down the reset rate. By turning the “vent ring” to completely or partially cover the ventilation holes, the hygroscopic discs will dry more slowly. This adjustment can compensate for an overly sunny installation location or peculiar soil conditions. Experimenting with the vent ring will best determine the ideal vent setting.

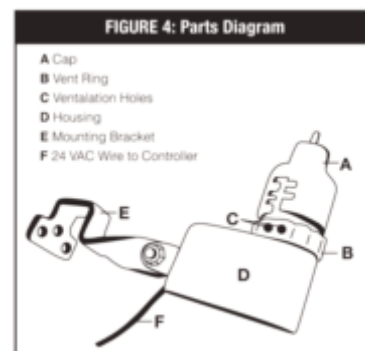

BYPASSING THE SENSOR

Should you desire to bypass the operation of rain sensor for any reason there is an easy way to do this. Simply go to the rain sensor and raise the quantity “cap” setting higher, or completely remove it altogether. This takes the pressure off the switch button, which allows the valve circuit to close again.

MAINTENANCE

There is no required maintenance for the unit. The rain sensor does not have to be removed or covered for winterizing purposes.

TROUBLESHOOTING

Follow these simple checks before replacing your rain sensor.

System does not come on at all:

- Check to see that the rain sensor discs are dry and the switch clicks on and off freely by pressing the top of the spindle.
- Look for breaks in the wire leading to the rain sensor and check all wire junctions.
- If the rain sensor is dry and the wire leading to it is good, check the rain sensor switch by nicking the insulation of the two outer wires near the unit to expose copper. Turn one sprinkler zone on, and apply a jumper wire across the two exposed wires. If the sprinkler now comes on, the switch is bad. Wrap all nicked wires with electrical tape.
- The rain sensor is wired to function with most controllers (normally closed). If you are unable to make the sensor work with the suggestions above you may have a unique controller (normally open).

System will not shut off even after heavy rainfall:

- Check wiring for correct installation.
- Check sensitivity on rain sensor, and move the cap to a more sensitive setting. The rain sensor is an accurate rain gauge and can be verified by setting up a “tube” type rain gauge in the same vicinity and making periodic readings.
- Check for obstructions to rainfall such as overhangs, trees or walls.



TFV Series

TFV Irrigation Solenoid Valve Features:

- Rugged glass-reinforced nylon construction.
- For residential, commercial and agricultural irrigation systems only.
- High strength, long life natural rubber diaphragm.
- In line globe design.
- Normally closed valve provides slow and smooth opening and closing.
- Quarter turn downstream bleed lever allows manual operation without external water spills.
- High flow rate with low head loss.
- Flow control available for exact water flow adjustment.
- Accurate operation over a wide range of pressure flows.
- In line maintenance - No need to remove valve from line for service.
- Standard and flow control models available.
- Available with standard 24 volt or optional 110 volt solenoid.
- Normally open valves are also available on a special order basis. Call for special pricing.

**** NO RETURNS on special order N/O valves.**

TFV Series irrigation solenoid valves are designed and intended for use in turf irrigation applications only. While these valves may operate in applications other than they are intended, the AGI warranty will not apply for those uses.

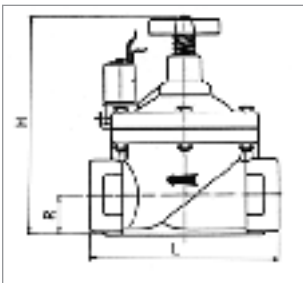

Flow Chart For Fully Open Valves

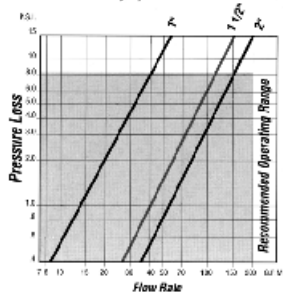

Specifications:

- Voltage24 Volts AC 3 Watts
- CurrentInrush .48 AMPS;
.....Holding .24 AMPS
- Max. Working Temp180°F
- Max. Operating Pressure150 PSI
- Min. Operating Pressure10 PSI
- Recommended minimum
pressure differential7 PSI
- Valve BodyGlass reinforced Nylon
- Inner Plastic PartsAcetal
- DiaphragmNatural rubber
- SealsBuna-N
- Metal Parts and ScrewsStainless Steel 303

Part Number	Size (FPT)	Volts	Flow Control	Weight	Dimensions				Ctn Qty
					L	H	R	Width	
TFV100T	1"	24	No	12.5 oz	4 5/16	2 1/2	7/8	3 1/16	20
TFV100T110V	1"	110	No	12.5 oz	4 5/16	2 1/2	7/8	3 1/16	20
TFV100TF	1"	24	Yes	12.5 oz.	4 5/16	4 1/2	7/8	3 1/16	20
TFV100TF110V	1"	110	Yes	12.5 oz.	4 5/16	4 1/2	7/8	3 1/16	20
TFV150TF	1 1/2"	24	Yes	2.2 lbs.	6 5/16	7 3/16	15/16	5	5
TFV150TF110V	1 1/2"	110	Yes	2.2 lbs.	6 5/16	7 3/16	15/16	5	5
TFV200TF	2"	24	Yes	2.2 lbs.,	6 3/4	7 3/8	1 1/2	5	5
TFV200TF110V	2"	110	Yes	2.2 lbs.,	6 3/4	7 3/8	1 1/2	5	5

Replacement Solenoid Assemblies

H701-24	24 volt
H701-110	110 volt

P73 Cut-off Nipples Features:

- Patented design 4 in 1 nipple allows choice of length, excess becomes additional useable nipples.
- 100 PSI (max) and 201 °F max temperature.
- Green

Poly Cut-off Nipple, Riser Extension and Poly Nipple Features:

- Black poly

SW500 Nipple Extractor Features:

- For 1/2" or 3/4" plastic nipples.
- Easy to remove broken plastic riser from sprinkler pipe and fittings.
- Insert tip and turn.



P-73 Series

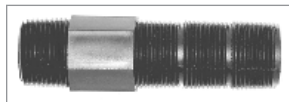

PCO Series

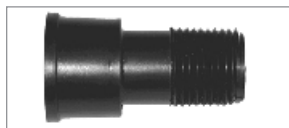

RE Series



RECO Series



PN Series



SW500C

Part Number	Description	Ctn Qty
Cut-off Nipples		
P73-1/2	1/2" MIPT x 1/2" MIPT x 6"	50
P73-3/4	3/4" mipt x 3/4" mipt x 6"	25
P73-3/4x1/2	Reducing, 3/4" mipt x 1/2" mipt, 6"	40
Poly Cut-off Nipples		
PCO1/2X4	1/2" x 4" MPT x MPT	500
PCO1/2X6	1/2" x 6" mpt x mpt	500
PCO1/2X3/4X4	1/2" x 3/4" x 4" mpt x mpt	500
PCO1/2X3/4X6	1/2" x 3/4" x 6" mpt x mpt	400
PCO3/4X4	3/4" x 4" mpt x mpt	400
PCO3/4X6	3/4" x 6" mpt x mpt	400
Riser Extensions		
RE1/2X1	1/2" x 1" fpt x mpt	1000
RE1/2X1 1/2	1/2" x 1 1/2" fpt x mpt	1000
RECO1/2X4	1/2" x 4" fpt x mpt	500
RECO3/4XSHORT	3/4" x Short fpt x mpt	500
RECO3/4X4	3/4" x 4" fpt x mpt	400
Poly Nipples		
PN1/2XCLOSE	1/2" x close	1000
PN1/2X3/4XCLOSE	1/2" x 3/4" x close	1000
PN3/4XCLOSE	3/4" x close	1000
PN1/2X2	1/2" x 2"	1000
PN1/2X3	1/2" x 3"	500
PN1/2X4	1/2" x 4"	500
PN1/2X5	1/2" x 5"	500
PN1/2X6	1/2" x 6"	500
PN1/2X8	1/2" x 8"	50
PN1/2X10	1/2" x 10"	50
PN1/2X12	1/2" x 12"	50
PN1/2X18	1/2" x 18"	50
PN1/2X24	1/2" x 24"	50
Nipple Extractors		
SW500C	Stub Wrench	50

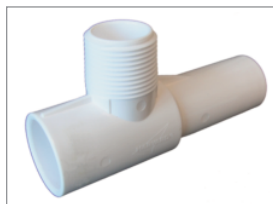

94-11

Irrigation Valve Manifold Tee Features:

- Uniformly spaced installation of manifolds for 1" irrigation valves.
- Designed to be mounted horizontally for electric globe valves or installed with the threaded outlet upright to accommodate angle valves.
- Schedule 40 PVC.

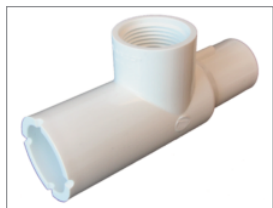
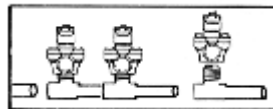

1376-010

94-11, 1376 Series Manifold Tees:

- Aligns valves with integral notch and key design on 1376-010.
- Preset spacing of valves.
- Sch 40 wall thickness.
- Full flow 1" main line with 1" mpt (94-11) or 1" fpt (1376-010).
- Pressure rated at 315 psi, tested to over 1000 psi.



HMT70-1G

HMT70-1G Manifold Tee:

- 1" IPS threads compatible with all 1" valves.
- Hand tight assembly in series for a uniformly spaced sprinkler manifold.
- Riser always positions correctly, self aligning when tightened until threads no longer show.
- Schedule 40 PVC with Buna N o-ring seal.



91-11

91 Series PVC Cross Tee Manifold:

- Uniformly spaced side by side installation.
- 1" mpt connections.
- Schedule 40 PVC.

Part Number	Description	Ctn Qty
94-11	1" soc x 1" slip x 1" mpt	50
1376-010	1" soc x 1" slip x 1" fpt	6
HMT70-1G	1" fpt x 1" mpt x 1" mpt	12
91-11	1" soc x 1" mpt x 1" slip x 1" mpt	8



HMRA1/2x3/4

HMRA Adapter Features:

- 1/2" x 3/4" mipt Reducing Adapter

Part Number	Description	Ctn Qty
HMRA 1/2 x 3/4	1/2" x 3/4" MIPT Reducing Adapter	50

Garden Hose Thread Fittings

- Material: PVC Type I White, or brass

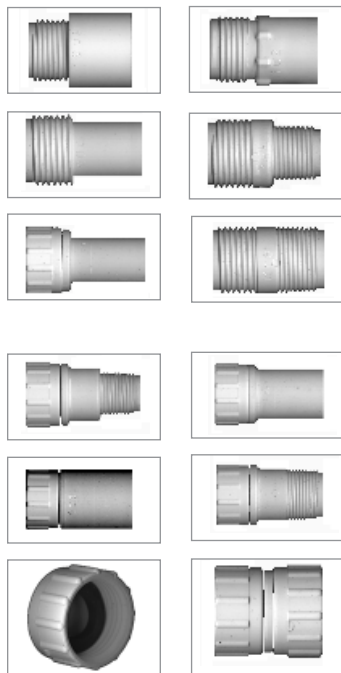

Part Number	Size	Connections	Ctn Qty
Garden Hose Thread Fittings - MALE			
MHT-101	3/4" x 1/2"	MHT x Slip	25/200
MHT-102	3/4" x 1/2"	MHT x FIPT	25/200
MHT-103	3/4"	MHT x Slip	25/200
MHT-104	3/4" x 1/2"	MHT x MIPT	25/200
MHT-105	3/4" x 1/2"	MHT x Spigot	25/200
MHT-106	3/4"	MHT x MIPT	25/200
Garden Hose Thread Fittings - FEMALE			
FHT-201	3/4" x 1/2"	FHT x Spigot	25/200
FHT-202	3/4" x 1/2"	FHT x Slip	25/200
FHT-203	3/4" x 1/2"	FHT x MIPT	25/200
FHT-204	3/4"	FHT x MIPT	25/200
FHT-205	3/4"	FHT x Slip	25/200
FHT-206	3/4"	FHT x FIPT Swivel	25/200
BFHT-206	3/4"	FHT x FIPT Swivel BRASS	5/60
FHT-207	3/4"	FHT x FHT swivel	20/500
FHT-301	3/4"	FHT CAP	25/200

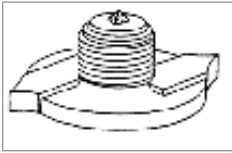

HP2000



OD2



SD1000

Drain and Adapter Features:

- Freeze protection.
- Easy installation without tools.
- Dirt stopper screen keeps sand, dirt and sediment out of system.
- Hammer slug for easy installation on reducing elbows.
- Recessed wicking pad.



SD1000 Siphon Drain Features:

- Freeze protection. Protects mainlines, sprinkler heads, pipe, low spots, and end lines.
- New or existing irrigation systems. 3 sec. installation, no tools necessary.
- One drain for 1/2" thru 1" polyethylene and PVC pipe.

Part Number	Description	Use For	Ctn Qty
Drains			
HP2000	1/2" MPT Drain	Lateral line	25/500
HP3000	3/4" MPT Drain	Lateral line	25/400
HP4000	1/2" MPT Drain	Main line	25/500
SD1000	Fits 1/2" thru 1" pipe	Siphon Drain	25/200
Reducing Elbows			
OD2	1 x many fitting and OD1 drain	Poly end of line	200



500



Mini Trol® Water Hammer Arrestor Features:



- Mini Trol takes the bang out of water lines.
- Effectively intercepts surges in water lines.
- Prevents damage and shock waves by quick closing valves.
- Designed with pre-pressurized, permanent air chamber separated from water by a sealed-in heavy duty diaphragm.
- Chamber is polypropylene lined. Water never touches steel.
- Guaranteed not to waterlog or lose air.
- Manufactured for AGI in a ISO9001 facility.

Max. Supply Pressure:	90 psi
Max. Working Pressure:	150 psi
Max. Water Temperature:	200 °F

Part Number	Description	Ctn Qty
500	Mini-Trol 4 1/2" H x 3 3/8" W x 1/2" MPT	24



DST Saddle Tee

HARVARD CONTRACTOR'S Plastic Saddle Tees for Polyethylene Pipe:

- Heavy duty PVC saddle tee bodies with glass-reinforced nylon T-bolts and nuts.
- Molded barb seal for superior sealing to poly pipe. Barb seals deeper and tighter as the poly pipe pressurizes. No o-rings or gaskets needed.
- Withstands over 400 psi without leaking.
- 2 1/2" length protects seal area if pipe is kinked or damaged near saddle tee.
- **NO FLOW RESTRICTION**
- **NOT for use on RIGID PVC Pipe.**



Part Number	Pipe Size	Color	Outlet FPT	Bag/Ctn Qty
HARVARD CONTRACTOR'S Plastic Saddle Tees				
DST3/4x1/2	3/4"	Gray	1/2"	10/250
DST3/4x3/4	3/4"	Gray	3/4"	10/250
DST1x1/2	1"	White	1/2"	10/250
DST1x3/4	1"	White	3/4"	10/250
DST11/4x1/2	1-1/4"	White	1/2"	10/250
DST11/4x3/4	1-1/4"	White	3/4"	10/200



ND Series

HARVARD CONTRACTOR'S Plastic Saddle Tee Installation Tool Features:

ND Series Nut Driver:

- Glass-reinforced nylon for durability and strength.

HC Series Coring Tool:

- Spring-loaded self-retracting blade.
- Cuts a clean, burr-free, sawdust-free hole in seconds.



HC Series

Part Number	Description	Ctn Qty
Coring Tools/Nut Driver (for DST Series)		
ND375	9/16" Nut Driver	1
HC45	Coring Tool for DST Saddle Tees w/1/2" fipt outlet	1
HC55	Coring Tool for DST Saddle Tees w/3/4" fipt outlet	1



HBST Saddle Tee

HARVARD BRONZE Saddle Tees for Polyethylene Pipe:

- Bronze (81% copper) body to prevent material breakdown when buried.
- Stainless steel slotted screws.
- Leakproof, rubber gasket seal.
- **NOT for use on RIGID PVC pipe.**



Part Number	Pipe Size	Color	Outlet FPT	Bag/Ctn Qty
HARVARD Bronze Saddle Tees				
HBST 3/4x1/2	3/4"		1/2"	200
HBST 3/4x3/4	3/4"		3/4"	200
HBST 1x1/2	1"		1/2"	200
HBST 1x3/4	1"		3/4"	200
HBST 11/4x1/2	1-1/4"		1/2"	120
HBST 11/4x3/4	1-1/4"		3/4"	100
HBST 11/2x1/2	1-1/2"		1/2"	100
HBST 11/2x3/4	1-1/2"		3/4"	100
HBST 11/2x1	1-1/2"		1"	72
HBST 2x1/2	2"		1/2"	80
HBST 2x3/4	2"		3/4"	60

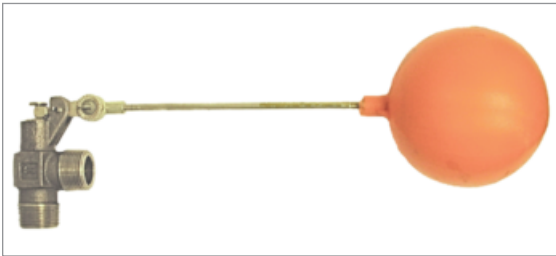

NO LEAD Bronze Float Valve Features:

- NO LEAD bronze body
- Buna-N Disc
- Heavy Duty
- Tapped for 1/4"-20SAE rod
- Threaded outlet
- Rated at 125 psi
- Third party certified to NSF/ANSI 372.



BFV Series

Part Number	Size	Inlet	Outlet	Tapped	Ctn Qty
BFVNL1/2	1/2"	1/2" mpt	1/2" mpt	1/4"-20SAE	10/100
BFVNL3/4	3/4"	3/4" mpt	3/4" mpt	1/4"-20SAE	10/80
BFVNL1	1"	1" mpt	1" mpt	1/4"-20SAE	10/40



BFVR Series

Stainless Steel Rods Features:

- Stainless Steel SAE
- Male thread both ends
- Third party certified to NSF/ANSI 372.



Part Number	Length	Thread	Fits Valve Size	Ctn Qty
BFVR8	8"	1/4"-20SAE	1/2" - 1"	50/400
BFVR10	10"	1/4"-20SAE	1/2" - 1"	50/300
BFVR12	12"	1/4"-20SAE	1/2" - 1"	50/300



BFVFP Series

Plastic Float Features:

- PVC, Corrosion resistant.
- Lightweight
- Up to 175 °F
- For open tank service only
- Bronze or NO LEAD bronze threaded connection.
- Third party certified to NSF/ANSI 372.



Part Number	Float Diam.	Buoyancy	Female Connection	Ctn Qty
BFVFPNL5	5"	2.17 lbs.	1/4"-20SAE	100
BFVFPNL6	6"	3.8 lbs.	1/4"-20SAE	100
BFVFPNL8	8"	9.87 lbs.	1/4"-20SAE	20



BS Saddle Tees

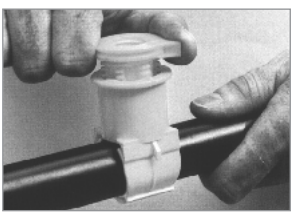

BS Series Blazing Saddle Manufactured by TOM KING HARMONY PRODUCTS



- Less flow restriction than an insert fitting.
- **BS Series for use on Polyethylene Pipe**
- **BS-PVC Series for use on PVC Pipe**
- Labor savings. No tools required. 10 sec installation w/ minimal digging.
- Withstands over 400 psi without leaking. Tested over 700,000 cycles at 60 psi.
- All plastic construction, no gaskets, seals, moving parts or clamps.
- Slip over pipe, apply pressure to top to lock in place, thread spike into saddle until locked.

Part Number	Pipe Size	Outlet FPT	Ctn Qty
Blazing Saddle			
BS4000	3/4"	Swing Pipe Barb	25/250
BS5000	3/4"	1/2"	25/250
BS6000	3/4"	3/4"	25/250
BS7000	1"	1/2"	25/250
BS8000	1"	3/4"	25/250
BS9000	1"	Swing Pipe Barb	25/250
BS5PVC	3/4"	1/2"	25/250
BS6PVC	3/4"	3/4"	25/250
BS7PVC	1"	1/2"	25/250
BS8PVC	1"	3/4"	25/250



Clamp-It™ PVC Saddle Tees for Rigid Pipe Features:

- Use for turf and irrigation systems, golf courses, athletic fields.
- Use for water service lines, mines, landfills.
- Provides full and equal support around the entire circumference of the pipe.
- Easy to install hinge and clamping wedge eliminates need for metal screws.
- Made of high impact type II PVC.
- EPDM O-ring seal.
- Rated at 200 PSI at 72 °F.
- For use on cold water lines only, 2" - 8" PVC.



Clamp-It™ PVC Saddle Tee



1. Place saddle on desired location and mark. Drill hole according to Drill Chart and deburr.



2. Place saddle over hole and attach easy clamping hinge around pipe.



3. Apply wedge half way by hand and finish off with a slight tap of a rubber mallet. Ideal for new installations or additions.

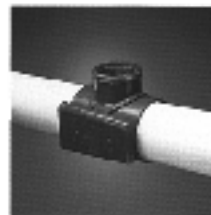

4. Saddle should be pressure tested prior to burial to assure system integrity. Long lasting EPDM o-ring seal assures a leak free installation. Note: wedge does not need to be flush with saddle body to seal.

Saddle Drill Sizes:

Outlet size	Drill Size
over 2 1/2" pipe	
3/4" IPS Slip & Fipt	3/4"
1" IPS Slip & Fipt	1"
1 1/4" IPS Slip & Fipt	1 1/4"
1 1/2" IPS Slip & Fipt	1 3/8"

* For 2 1/2" IPS saddle with a 2" outlet - Drill size must be 1 3/4" due to pipe restriction.

Part Number	IPS Pipe Size	Tap Size	Ctn Qty
Clamp-It™ PVC Saddle Tees			
421507	1 1/2	3/4 fipt	5
421510	1 1/2	1 fpt	5
422007	2	3/4 fipt	5
422010	2	1 fipt	5
422012	2	1-1/4 fipt	5
422015	2	1-1/2 fipt	5
432010	2	1 slip	5
432012	2	1-1/4 slip	5
432015	2	1-1/2 slip	5
422507	2-1/2	3/4 fipt	5
422515	2-1/2	1-1/2 fipt	5
422520	2-1/2	2 fipt	5
432510	2-1/2	1 slip	5
432515	2-1/2	1-1/2 slip	5
432520	2-1/2	2 slip	5

See next page for 3" - 8" CLAMP IT Saddle Tees.

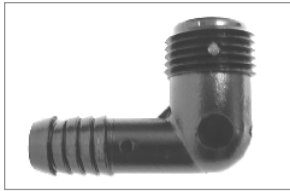

Swing Riser Fittings for Funny Pipe

- For use with Funny Pipe and other thick walled 1/2" ID tubing.
- Use in drip irrigation, home sprinkler systems & other residential irr. applications.
- Spiral barb design allows quicker twist-on installation.
- Made of Celcon® plastic resin providing long term durability.



Part Number	Size	Connections	Ctn Qty
90° Elbow			
SRE1/2	1/2" x 1/2"	MIPT x funny pipe barb (FPB)	100/1500
SRE3/4	3/4" x 1/2"	MIPT x FPB	50/1000
Male Adapter			
SRMA1/2	1/2" x 1/2"	MIPT x FPB	100/500
SRMA3/4	3/4" x 1/2"	MIPT x FPB	50/500
Coupling			
SRC1/2	1/2" x 1/2"	FPB x FPB	50/500

Lasco Swing Riser Fittings for Funny Pipe with Double Helix design

Part Number	Size	Connections	Ctn Qty
90° Elbow			
3300-005	1/2" x 1/2"	MIPT x funny pipe barb	500
3300-007	3/4" x 1/2"	MIPT x funny pipe barb	500
Male Adapter			
3400-005	1/2" x 1/2"	MIPT x funny pipe barb	100
3400-007	3/4" x 1/2"	MIPT x funny pipe barb	100



TRANSITION FITTINGS MARLEX™ STREET ELBOWS

- Ideal for use in swing joints.
- More than 27% heavier than other elbows, providing added strength & durability.

Part Number	Size	Connection	Ctn Qty
MSE1/2	1/2" x 1/2"	mipt x fipt	50/500
MSE3/4	3/4" x 3/4"	mipt x fipt	25/350
MSE1	1" x 1"	mipt x fipt	25/100



LASCO Double Helix SW Series

Transition Fittings for Irrigation Applications

- Save money on material and labor cost.
- Faster, easier installation.
- Retaining spikes to prevent movement on Dawn fittings.
- Double helix design on LASCO fittings.



LASCO Double Helix / KWIKADAPT SW Series Fitting Features:

- One piece design to go from Poly to swing/funny pipe.
- Use instead of a combo insert tee and a swing elbow.
- Available in 3/4" and 1".
- LASCO double helix fitting pipe connection.

Part Number	Description	Ctn Qty
LASCO - Poly to Swing/Funny Pipe Double Helix Design		
1429-099	3/4" Insert x Swing /Funny Pipe Coupling	10
1429-129	1" Insert x Swing /Funny Pipe Coupling	10
1401-099	3/4" Insert x Swing/Funny Pipe Tee	10
1401-129	1' Insert x Swing/Funny Pipe Tee	10

Part Number	IPS Pipe Size	Tap Size	Ctn Qty
453007	3	3/4 slip	5
453010	3	1 slip	5
453012	3	1-1/4 slip	5
453015	3	1-1/2 slip	5
453020	3	2 slip	5
443007	3	3/4 fipt	5
443010	3	1 fipt	5
443012	3	1-1/4 fipt	5
443015	3	1-1/2 fipt	5
443020	3	2 fipt	5
454007	4	3/4 slip	5
454010	4	1 slip	5
454015	4	1-1/2 slip	5
454020	4	2 slip	5
444007	4	3/4 fipt	5
444010	4	1 fipt	5
444012	4	1-1/4 fipt	5
444015	4	1-1/2 fipt	5
444020	4	2 fipt	5
456007	6	3/4 slip	5
456010	6	1 slip	5
456015	6	1-1/2 slip	5
456020	6	2 slip	5
446007	6	3/4 fipt	5
446010	6	1 fipt	5
446012	6	1-1/4 fipt	5
446015	6	1-1/2 fipt	5
446020	6	2 fipt	5
458010	8	1slip	5
458015	8	1-1/2 slip	5
458020	8	2 slip	5
448007	8	3/4 fipt	5
448010	8	1 fipt	5
448020	8	2 fipt	5



**Clamp-It™ PVC
Saddle Tee**

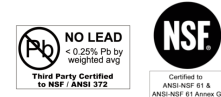

Part Number	Description	Ctn Qty
WEDGE 225	Wedge, Fits 2" and 2-1/2" Saddles	1
WEDGE 380	Wedge, Fits 3" and 4" Saddles	1
WEDGE 480	Wedge, Fits 6" and 8" Saddles	1

Replacement O-rings available for all size PVC Saddle Tees.
Contact your customer service representative for sizing and pricing.



SWING JOINT ASSEMBLIES

- Fully assembled swing assemblies with funny pipe.
- Includes marlex elbow.
- Available in additional lengths or without marlex elbow by special order.

Part Number	Size x Length	Connection	Ctn Qty
SA125050	1/2" x 1/2" x 12"	mipt x mipt (marlex ell)	50
SA125075	1/2" x 3/4" x 12"	mipt x mipt (marlex ell)	50
SA127575	3/4" x 3/4" x 12"	mipt x mipt (marlex ell)	50



POLY SWING PIPE

- Highly flexible.
- Use with swing riser fittings for a flexible swing joint assembly.
- LLDPE for increased flexibility.
- Up to 100 psi working pressure at 72 °F.
- Shrink wrapped coils.



Part Number	Size	Ctn Qty
PSP50-100	1/2" x 100' roll	1

3M® DBO/B-6 and DBR/Y-6 Direct Burial Splice Connector Features:



HDBR/Y-6 Splice Tube and Connector

UL Listed for Direct Burial, Rated for 600V.
Replaces existing 3M DBY, DBR, DBY6, DBR6, DBR/Y.

- Electrically connects two or more pre-stripped copper wires
- Provides moisture seal of the connections for the direct burial.
- Ideal for splicing wires and cables in irrigation and low voltage lighting systems.
- For residential, commercial, golf and other green industry applications.
- Smaller profile DBO/B-6 Series connectors are used when a larger size range of wires is not needed.
- May be installed above or below ground, inside a valve box or buried next to a valve-in-head sprinkler or light fixture.
- Not recommended for submersible applications.
- Each kit includes a 3M Performance Plus quick biting wire connector O/B+ or R/Y+ and a high impact, UV resistant polypropylene tube prefilled with moisture-resistant grease.
- The gel filled tube includes a lid that compresses the wire insulation when closed. This applies pressure, known as "strain relief" that keeps the connection inside the tube when the wires are pulled-upon. The connector tube includes channels for three sets of wires.
- 3M Electrical products are manufactured for AGI in an ISO 9002 facility.



Specifications:

Maximum voltage rating:
600 volts.
UL Listed, File No. E102356
UL Listed 98U1
UL Standard 486D
Application temperature:
32 °F to 120 °F
Operating temperature:
-40 °F to 221 °F.

Construction:

Tube: Impact and UV
Resistant Polypropylene
Grease: 711B (DBO) Mineral Oil
Based, EG3 (DBR)
O/B+ or R/Y+ Connector: Steel
Spring, Flame Retardant
Insulator

Common AWG Wire Combinations - CV only

DBO		DBR	
2-3 #16 sol/str	1 #18 to 1-2 #14 sol/str	2 - 7 #18	1-3 #12 w/ 1 #18
2-3 #14 sol/str	1 #18 to 1-2 #12 sol/str	2 - 6 #16	1-2 #10 w/ 1 #18
2 #12 sol/str	1 #16 to 1-2 #14 sol/str	2 - 4 #14	1-3 #12 w/ 1 #16
1 #14 to 1 #12 sol/str	1 #16 to 1-2 #12 sol/str	2 - 4 #12	1-2 #10 w/ 1 #12
		2 - 3 #10	1-2 #14 w/ 1 #18

See complete chart of combinations on reverse.

Installation:

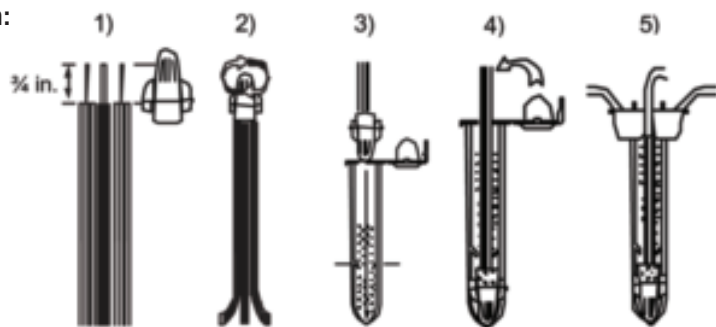

Part Number	Description	Ctn Qty	Pallet Qty
CHDBO/B-6	3M® Direct Bury Splice Kit, Bulk	100	
HDBO/B2-6	3M® Direct Bury Splice Kit, 2 per package	25	
CHDBR/Y-6	3M® Direct Bury Splice Kit, Bulk	100	7500
HDBR/Y2-6	3M® Direct Bury Splice Kit, 2 per package	25	-

Combination Chart

- The connectors accept a multitude of direct burial copper wire combinations, as listed in the tables below.



DBO

WIRE COMBINATIONS
AWG CU TO CU ONLY

HOW TO READ THIS CHART

EXAMPLE 1

EXAMPLE 1: 1 No. 16 str to 2 No. 16 str

EXAMPLE 2: 1 No. 10 sol to 1 No. 16 str

18 STR	1	••••																		
18 SOL	1	••••	••••																	
16 STR	1	••••	••••	••••																
16 SOL	1	••••	••••	••••	••••															
14 STR	1	••••	••••	••••	••••	••••														
14 SOL	1	••••	••••	••••	••••	••••	••••													
12 STR	1	••••	••••	••••	••••	••••	••••	••••												
12 SOL	1	••••	••••	••••	••••	••••	••••	••••	••••											
10 STR	1	••••	••••	••••	••••	••••	••••	••••	••••	••••										
10 SOL	1	••••	••••	••••	••••	••••	••••	••••	••••	••••	••••									
		1 2 3 4	1 2 3 4	1 2	1 2	1 2	1 2	1 2	1 2	1 2	1 2	1 2	1 2	1 2	1 2	1 2	1 2	1 2	1 2	1 2
		18 STR	18 SOL	16 STR	16 SOL	14 STR	14 SOL	12 STR	12 SOL											

DBR

18 STR	1	••••																		
18 SOL	1	••••	••••																	
16 STR	1	••••	••••	••••																
16 SOL	1	••••	••••	••••	••••															
14 STR	1	••••	••••	••••	••••	••••														
14 SOL	1	••••	••••	••••	••••	••••	••••													
12 STR	1	••••	••••	••••	••••	••••	••••	••••												
12 SOL	1	••••	••••	••~••	••~••	••~••	••~••	••~••	••~••											
10 STR	1	••~••	••~••	••~••	••~••	••~••	••~••	••~••	••~••	••~••										
10 SOL	1	••~••	••~••	••~••	••~••	••~••	••~••	••~••	••~••	••~••	••~••									
		1 2 3 4	1 2 3 4	1 2 3 4	1 2 3 4	1 2 3 4	1 2 3 4	1 2 3 4	1 2 3 4	1 2 3 4	1 2	1 2	1 2	1 2	1 2	1 2	1 2	1 2	1 2	1 2
		18 STR	18 SOL	16 STR	16 SOL	14 STR	14 SOL	12 STR	12 SOL	10 STR	10 SOL									

Example:
3 #14 SOL and 1 #12 STR

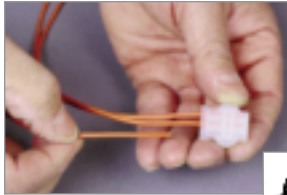

SSP314



3M® SSP Series Insulation Displacement Connector

Features:

- Used to electrically connect two or three wire ends & insulate the connection.
- #22-#14 AWG range on SSP314. SSP314 is UL and CSA listed.
- #22-#16 AWG range on SSP316.
- Also used for pigtail 2- and 3-wire splicing.
- Connector provides a moisture-resistant seal and is flame retardant.



LV9000

Tom King Harmony Snaplock Wire Connector Features:

- Gel-filled 100% waterproof.
- Double o-ring, double-latch locking system.
- For low voltage connections.



art Number	Description	Ctn Qty
SSP314	3M® Insulation Displacement Connectors #22-#14 AWG	1000
SSP316	3M® Insulation Displacement Connectors #22-#16 AWG	300
Snaplock Gel-filled Wire Connector		
LV9000	Small- fits two #24 - seven #18 AWG	24/720
LV9500	Large - Fits two #18 - three #10 & one #18 AWG	12/432



82-A

Scotchcast™ 82-A Series Inline Resin Splice Kit Features:

- Insulate and seal single conductor, unshielded cable splices & multiple conductor cables.
- Connector is not included.

Part Number	Conductor	Cable OD	Conn OD	Ctn Qty
82-A2	2-3/0 AWG	1"	0.625"	10



VL1

CLICK-IT™ Valve Locator Features:

- Water resistant.
- Compact design.
- For location of solenoid valve quickly and easily.
- Practical and cost effective.

Part Number	Description	Ctn Qty
VL1	Click-It Valve Locator	10



PTC163-6 Series



PTC143-6RA220

HARVARD CONTRACTOR'S Power Cord Features:

- Three prong right angle (115V, 220V) molded plugs.
- 16 gauge, 3 conductor, 13 amp, 125 Volt rating.
- 14 gauge, 3 conductor, 15 amp, 250 Volt rating.
- Six foot cord length.
- Free end is split, stripped 3/8".
- UL and CSA listed in US and Canada.

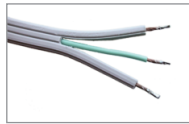
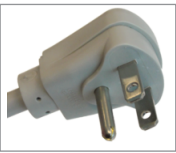

Part Number	Description	Wire Gauge	Volt Rating	Ctn Qty
PTC163-6ST	Straight plug cord	16	125 V	50
PTC163-6RA	Right angle plug cord	16	125 V	50
PTC143-6RA220	Right angle plug cord	14	250 V	50



HARVARD CONTRACTOR'S Anchor Kit Features:

- Anchor kits complete with 100 plastic anchors, 100 screws and 1/4" masonry drill bit in a plastic case.
- Plastic gray ribbed anchors with lip design for electronic timer, pump start relay installations. Use with concrete block, brick and wallboard.
- Anchors have internal ribs for better centering of screws, locking lugs against pull and twist. Exterior design prevents fall out in overhead holes.
- Kit available with combination slotted/phillips head or tri-combination, slotted/phillips/hex head #10 x 1" screws.
- Kits complete with 1/4" x 4" masonry drill bit.
- Clear, unbreakable plastic case with molded-in hanging tab.



Combo Head

Tri Combo Head



Part Number	Description	Ctn Qty
AK10CSPR	Ribbed Combo Head	36
AK10TCR	Ribbed Tri Combo Head	36



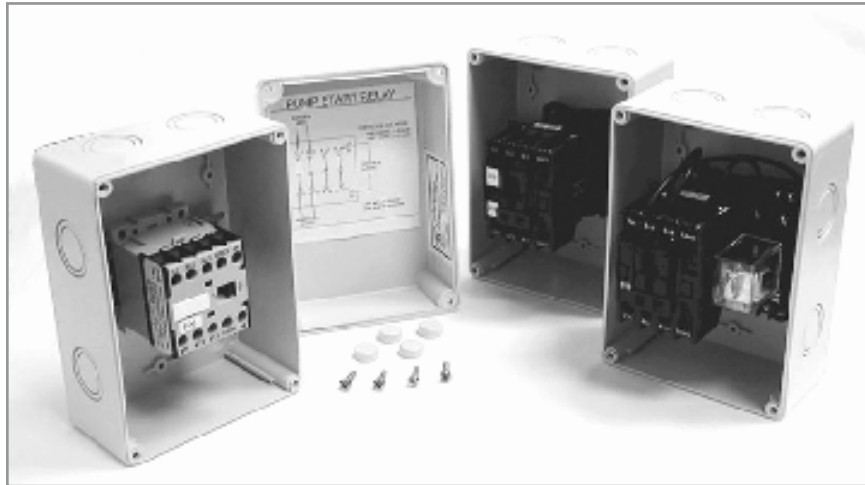

Pump Start Relay Features:

- Contactors are UL and UL Canada rated.
- Wide coil operating range, +10% to -30% of rated 60 hz coil voltage.
Contactors will start on low voltage as follows:
Single phase: 24 VAC coil will pull in at 17 volts.
120 VAC coil will pull in at 84 volts.
230 VAC coil will pull in at 161 volts.
- Finger safe design.
- One normally open auxiliary contact for powering a pilot light or alarm.
- Pressure screw terminals accept 18 through 10 AWG wire.
- Interposing relay units accept 24 through 10 AWG wire.
- Mechanical life up to 10 million operations.
- Long electrical life.
- PSR567 Series with interposing relay designed for low voltage and low controller output.

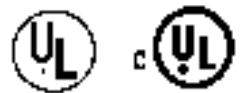

Industrial Non-metallic Enclosure Features:

- Gray enclosures are UL, CSA listed.
- Rated NEMA 4X for indoor or outdoor use.
- To maintain 4X enclosure rating use required 4X connectors.
- Watertight, dust tight, oil tight and rain tight.
- High impact, durable insulated Noryl thermoplastic.
- Neoprene gasketed cover.
- Resistant to shock, corrosion, chemicals and atmospheric agents.
- 8 conduit knockouts (1/2", 3/4" NPT combination.)
- Service temperature -40° to 260°F.
- Stainless steel cover screws (max tightening torque: 7 in-lbs.)
- Sealing plugs provided to waterproof mounting screws.
- 5.9" H x 4.3" W x 3.9" D





118 Series



Flo Span Expandable Repair Coupling Features:

- Double EPDM o-ring seal gives more protection from possible leakage due to deflection of piston in the extended position.
- EPDM o-ring seal also protects against contamination on the cylinder wall.
- Solvent cement trap located in cap to capture excess solvent cement.
- Made from PVC type I grade I material meeting ASTM D-1784
- 118 Series does not have union end.

NEW Part Number	IPS Size	Body Length	Ctn Qty
PVC Flo-Span Expansion Couplings - NO UNION S x SPG			
118-05	1/2"	7 1/2"	28
118-07	3/4"	7 3/4"	24
118-10	1"	9 1/2"	15
118-12	1-1/4"	10 3/4"	10
118-15	1-1/2"	12 3/4"	16
118-20	2"	13 1/2"	12
118-25	2-1/2"	18 3/4"	3
118-30	3"	21"	3
118-40	4"	22 3/4"	3
QF-6000	6" S x S	26 1/4"	1



PSC Series



Poly-Stretch Repair Coupling Features:

- For repair of polyethylene irrigation pipe.
- Avoid extra digging and buckled pipe.
- Couplings are made of ABS
- O-ring seal is made of Buna 70
- Pressure rated at 160 psi.
- Designed for irrigation operation pressures of polyethylene pipe and more.

Instructions for Installation:

- Cut out approximately 4" of pipe where repair is needed.
- Place clamps over ends of pipe
- Insert end marked with "END FIRST" arrow by pushing and turning at same time.
- Insert other end by pushing & turning.
- Place clamps over ribbed ends & tighten.

Dimensions:

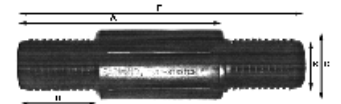

	A	B	C	D	E
3/4"	4.0	.575	.820	1.50	5.625
1"	4.0	.770	1.075	1.50	5.625
1 1/4"	5.0	1.109	1.415	1.755	6.70
1 1/2"	5.0	1.310	1.63	1.755	6.70
2"	5.0	1.825	2.125	1.755	6.70

Part Number	Description	Ctn Qty
PSC07	3/4" Poly-stretch coupling	50
PSC10	1" Poly-stretch coupling	50
PSC12	1 1/4" Poly-stretch coupling	25
PSC15	1 1/2" Poly-stretch coupling	25
PSC20	2" Poly-stretch coupling	20



Single ear pinch clamp Features and Benefits:

- 300 series stainless steel material for excellent corrosion resistance.
- Welded construction provides superior strength.
- Quick, easy installation provides a uniform 360° seal.
- Permanent seal is tamper proof.
- Ideal 61-0 series clamps are compatible with most clinching tools.
- Fits most popular polyethylene and polybutylene water service lines.
- Perfect for irrigation applications.



61001-51

Part Number	Nominal Size	Open Diameter	Closed Diameter	Bag Qty	Ctn Qty
61198	3/4"	0.779	0.669	100	2000
61210	13/16"	0.827	0.716	100	2000
61256	1"	1.008	0.898	250	2500
61271	1 1/16"	1.067	0.945	250	2500
61316	1 1/4"	1.244	1.122	250	2500
61331	1 5/16"	1.303	1.181	250	2500
61410	1 5/8"	1.614	1.492	100	2000
61425	1 11/16"	1.673	1.551	100	2000
61485	1 7/8"	1.909	1.787	100	2000
61001-51	Pinch tool for all size pinch clamps (EACH)				15

To identify proper clamp size:

Measure actual OD of the hose on the fitting. Select the nominal size clamp nearest but always larger than the OD of the hose on the fitting.

Quantities:

Bag quantities required.

Drop Ship Programs:

Minimum 5000 piece assorted pinch clamps required if ordered in combination with a 5000 piece worm drive clamp drop ship order. Minimum 25,000 piece assorted pinch clamps required if ordered separately. Standard customer pricing on pinch clamps applies.

Freight & Terms:

Standard AGI freight, terms and conditions apply.



PEX Series



PIC Series

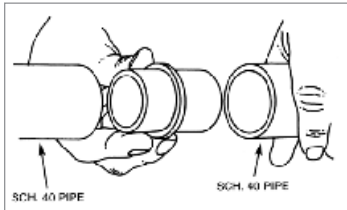
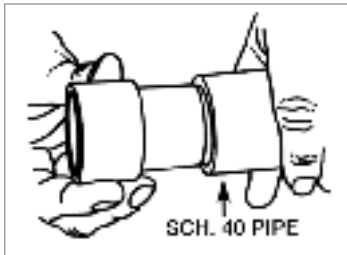

Pipe Extender and Inside Connector Repair Fitting Features:

- For Sch 40 pipe.
- Saves labor.
- Invisible after installation.
- Permanent repair.
- Insignificant flow restriction.
- PVC Construction.
- PIC Series connects two pieces of Sch 40 pipe with flush joint.

Part Number	Description	IPS Size	Ctn Qty
Pipe Extender Repair Fitting			
PEX50	Pipe Extender	1/2"	48
PEX75	Pipe Extender	3/4"	48
PEX100	Pipe Extender	1"	48
PEX125	Pipe Extender	1 1/4"	48
PEX150	Pipe Extender	1 1/2"	48
PEX200	Pipe Extender	2"	48
PEX250	Pipe Extender	2 1/2"	96
PEX300	Pipe Extender	3"	96
PEX400	Pipe Extender	4"	48
Inside Connector Repair Fitting			
PIC100	Inside Connector	1"	48
PIC150	Inside Connector	1 1/2"	48
PIC200	Inside Connector	2"	48



91025 & 91330

Submersible Utility Pump Features:

- 1/5 & 1/3 HP motors, 120 v, 60 Hz
- Corrosion resistant construction.
- 8' waterproof power cord.
- Clog resistant open type impeller.
- Capacities of 26 & 40 gpm.
- 1 year limited warranty.

Specifications:

Discharge: 1 1/4" MNPT
or 3/4" GHT



Housing & Base: Glass reinforced ABS

Impeller: Non-clogging open type

Bearing: Permanently lubricating

Motors: Permanent split capacitor,
continuous duty, thermally protected

Model No.	HP	Gallons per minute at discharge height in feet						Max. Head	Min. Amps
		0'	5'	10'	15'	20'	25'		
SP91025	1/5	26	21	14	10	7	1	25'	3.6
SP91330	1/3	40	34	28	22	12	2	25'	4.1

NOTE: Use of smaller diameter pipe, or long runs of pipe, will result in lower flow rates than those shown.



PVC Compression Fittings - IPS

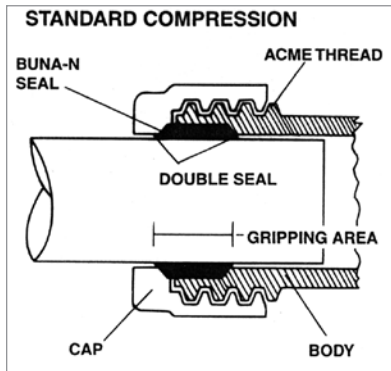

PVC Compression Fitting Features:

- Iron pipe size
- For use with cold water only.
- Buna-N gasket seals
- ACME compression cap threads
- Rated at 200 PSI.

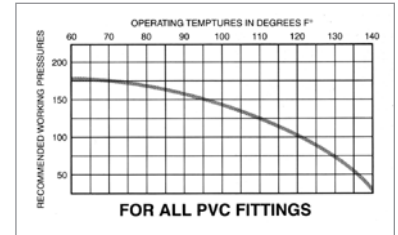

CPC Series IPS

NSF61 Annex G
UPC

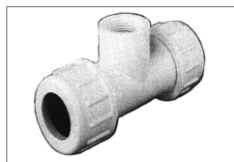

CPT-T Series IPS

NSF61 Annex G



CPT-S Series IPS

NSF61 Annex G
UPC

NEW Part Number	OLD Part Number	IPS Size	Body Length	Ctn Qty
PVC IPS Compression Couplings, comp x comp				
CPC0500	110-05	1/2"	4"	28
CPC0750	110-07	3/4"	4-1/4"	24
CPC1000	110-10	1"	4-1/2"	15
CPC1250	110-12	1-1/4"	5"	10
CPC1500	110-15	1-1/2"	5-1/2"	16
CPC2000	110-20	2"	6"	12
CPC2500	110-25	2-1/2"	8"	3
CPC3000	110-30	3"	9"	3
CPC4000	110-40	4"	10"	3
CPC6000	110-60	6"	10"	1
PVC IPS Threaded Tee, comp x comp x fipt				
CPT0500T	120-05	1/2"	4"	24
CPT0750T	120-07	3/4"	4-1/4"	20
CPT1000T	120-10	1"	4-1/2"	15
CPT1250T	120-12	1-1/4"	5"	15
CPT1500T	120-15	1-1/2"	5-1/2"	12
CPT2000T	120-20	2"	6"	10
PVC IPS Slip Tees, comp x comp x slip				
CPT0500S	121-05	1/2"	4"	24
CPT0750S	121-07	3/4"	4-1/4"	20
CPT1000S	121-10	1"	4-1/2"	15
CPT1250S	121-12	1-1/4"	5"	15
CPT1500S	121-15	1-1/2"	5-1/2"	12
CPT2000S	121-20	2"	6"	10

PVC Compression Fittings - IPS, CTS

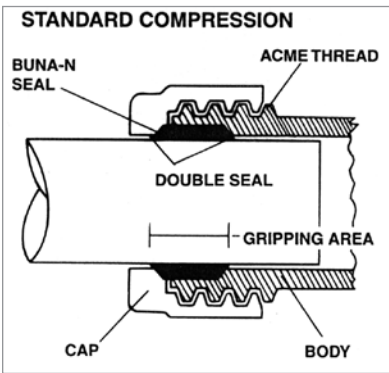

PVC Compression Fitting Features:

- Iron pipe size
- For use with cold water only.
- Buna-N gasket seals
- ACME compression cap threads
- Rated at 200 PSI.

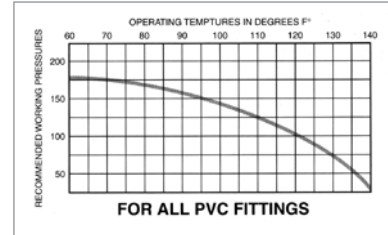

NSF61
Annex G

UPC

CPA Series IPS

NEW Part Number	Previous Part Number	IPS Size	Body Length	Ctn Qty
PVC IPS Male Adapter, comp x mipt				
CPA0750	130-07	3/4"	2 7/8"	20
CPA1000	130-10	1"	3 1/8"	30
CPA1250	130-12	1-1/4"	3 5/16"	20
CPA1500	130-15	1-1/2"	3 1/2"	16
CPA2000	130-20	2"	3 3/4"	12



NSF61
Annex G

UPC

CCC Series CTS

NEW Part Number	Previous Part Number	CTS Size	Body Length	Ctn Qty
PVC CTS Compression Coupling, comp x comp				
CCC0500	210-05	1/2"	4"	25
CCC0750	210-07	3/4"	4"	28
CCC1000	210-10	1"	4-1/4"	24
CCC1500	210-15	1 1/2"	5"	10
CCC2000	210-20	2"	6"	12

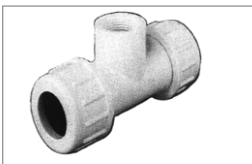

NSF61
Annex G

CCT Series CTS

NEW Part Number	Previous Part Number	CTS Size	Body Length	Ctn Qty
PVC CTS Threaded Tee, comp x comp x fipt				
CCT0500	220-05	1/2"	4"	36
CCT0750	220-07	3/4"	4"	24
CCT1000	220-10	1"	4-1/4"	18
CCT1250	220-12	1 1/4"	4-1/2"	12
CCT1500	220-15	1 1/2"	5"	15
CCT2000	220-20	2"	6"	10



CPVC Compression Fittings - IPS & CTS

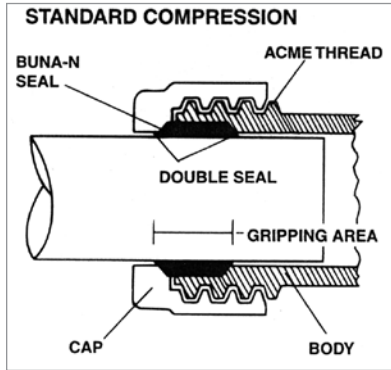

CPVC Compression Fitting Features:

- Iron pipe size & copper tube size
- For hot water use.
- Not to exceed 100 psi at 180 °F
- Buna-N gasket seals
- ACME compression cap threads
- Rated at 200 PSI.



410 Series CTS

Part Number	Size	Description	Body Length	Ctn Qty
CPVC CTS Compression Couplings, comp x comp				
410-05	1/2"	1/2" cts x 1/2" cts	4"	25
410-07	3/4"	3/4" cts x 3/4" cts	4"	28

TECHNICAL DATA FOR ALL FLO CONTROL FITTINGS & VALVES

1. PVC MATERIAL SPECIFICATION: PVC Type I, Grade I, Cell class 12454-B meeting requirements of ASTM D-1784-75 is used in the manufacturing of all fittings recommended for use of potable cold water (see temperature vs. pressure chart). Not recommended for use on systems exceeding 100 psi @ 120 °F.

2. CPVC MATERIAL SPECIFICATION: CPVC Type IV, Grade I, cell Class 23447-B meeting requirements of ASTM D-1784-75 is used in the manufacturing of all fittings recommended for use on potable hot water systems in accordance with ASTM D-2846-73. Not recommended for use on systems that will exceed 100 psi @ 180 °F.

3. BUNA-N SEALS: The gasket seal material is made of high quality Buna-N elastomeric compound which meets the requirements of ASTM D-2000. It is generally resistant to many hydrocarbons, fats, oils, greases, hydraulic fluids and chemicals. It is generally attacked by Ozone, Ketones, Esters, Aldehydes, chlorinated and nitro hydrocarbons. Reference chemical resistance under NBR (Nitrile) elastomers for specific listings.

4. EPDM O-RINGS: The o-ring material is made of high quality EPDM (Ethylene Polyene Copolymer) which meets the requirements of ASTM D-2000. EPDM has exceptionally good weather aging and ozone resistance, excellent water and chemical resistance and excellent aging resistance for most applications. EPDM is a polymer where oil and solvent resistance is poor. However, it is fairly good in ketones and alcohols. Reference chemical resistance under EPDM, EPT or EPR Elastomers for specific listings.

5. DOUBLE SEAL of standard compression fittings. A compressive action is created as the cap is tightened squeezing the Buna-N seals into the tapered

recessed areas of the cap and body. This process creates a highly concentrated pressure at the two "double seal" points, thus providing positive protection against leakage.

6. ACME THREAD: General purpose 10 pitch Acme thread on compression cap section, eliminates the possibility of cross threading. This smooth running design prevents binding or galling as is often experienced in standard tapered threads.

7. COMPRESSION CONNECTIONS: Compression cap should be drawn up hand tight to insure proper alignment and seating of gasket, then tighten 3/4 to 1 turn with a Flo Spanner Wrench or strap wrench. Average torque should be approximately 25 foot pounds on 1/2" through 2" IPS and 35 foot pounds on 2 1/2" and larger. Compression fittings are not recommended for use on compressed air lines or natural gas lines.

8. THREAD CONNECTIONS: Use PTFE thread seal tape on all IPS thread connections. IPS thread connections should be made hand tight plus 1/2 to 3/4 turn with a wrench.

9. THRUST BLOCKING: When installing the standard compression seal fittings the pipe line must be restrained from lateral movement by thorough soil compaction on straight runs and thrust blocking at change of direction or reduction in size. Not recommended for use on pipe lines suspended on hangers.

10. FLO LOCK COMPRESSION ADAPTERS: Recommended for use on PVC pipe with wall thickness of SDR-26, Class 160 or greater and copper tubing. Not recommended for use on galvanized pipe unless surface is sanded smooth. The gripper ring is made of stainless steel.

11. ALL SPRINGS made of Series 300 stainless steel.



www.cbsupplies.ca
Phone: (866) 503-5523 Fax: (888) 562-2095
AGI@cbsupplies.ca



Flo-Lock Fittings - PVC & CPVC

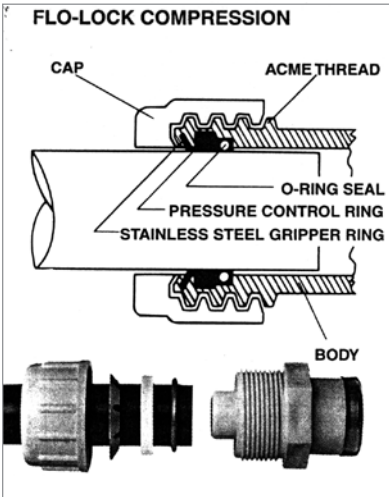

PVC/CPVC Flo-Lock Fitting Features:

- Iron pipe and copper tube size
- For cold (PVC) or hot (CPVC) water use.
- Built in stiffener to insure grip.
- EPDM o-ring seal
- PVC ring for controlling o-ring pressure.
- Stainless steel gripping ring prevents pull-out.
- Rated at 160 psi @ 72 °F.



NSF61 Annex G
UPC

135 Series IPS



NSF61 Annex G

136 Series IPS



NSF61 Annex G
UPC

235 Series CTS



435 Series CTS

Part Number	IPS Size	IPS Connection	Ctn Qty
PVC IPS Male Adapter with Flo-Lock, flo lock x mipt			
135-05	1/2"	1/2" mipt	25
135-07	3/4"	3/4" mipt	20
135-10	1"	1" mipt	30
135-12	1-1/4"	1-1/4" mipt	20
135-15	1-1/2"	1-1/2" mipt	16
135-20	2"	2" mipt	12
PVC IPS Female Adapter with Flo-Lock, flo lock x fipt			
136-05	1/2"	1/2" fipt	25
136-07	3/4"	3/4" fipt	20
136-10	1"	1" fipt	14
136-12	1-1/4"	1-1/4" fipt	18
136-15	1-1/2"	1-1/2" fipt	16
136-20	2"	2" fipt	10

Part Number	CTS Size	IPS Connection	Ctn Qty
PVC CTS Male Adapter with Flo-Lock, flo lock x mipt			
235-05	1/2"	1/2" mipt	50
235-07	3/4"	3/4" mipt	25
235-10	1"	1" mipt	18
235-12	1-1/4"	1-1/4" mipt	24
235-20	2"	2" mipt	12
CPVC CTS Male Adapter with Flo-Lock, flo lock x mipt			
435-05	1/2"	1/2" cts x 1/2" mipt	50
435-07	3/4"	3/4" cts x 3/4" mipt	25



PVC Flo-Lock Fittings - SDR9 polyethylene pipe

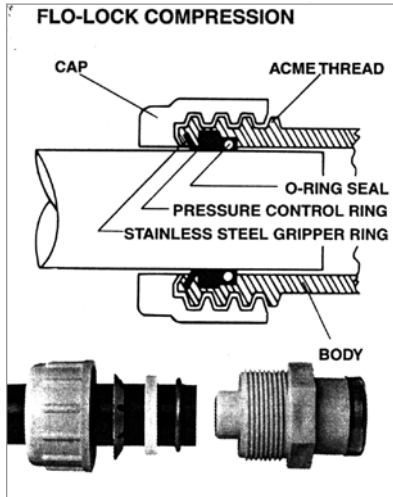

PVC Flo-Lock Series 700 Features:

- For water service line installations.
- Use on polyethylene pipe - tube size SDR-9-160 and 200, ASTM D2737.
- Reliable connections for polyethylene or copper tube.
- PVC type I material - 160 psi at 72 °F.
- Dry pull test exceeds 400 psi.
- Quick burst test exceeds 600 psi.
- Stainless steel band to reinforce female thread.
- Not for use with compressed air or natural gas lines.



IAPMO LISTED: Listed by the International Association of Plumbing and Mechanical Officials Research Committee as meeting the requirements set forth by the Uniform Plumbing Code for potable water systems. * Female threaded fittings are no longer IAPMO approved.

Series 700 Fittings for:
Polyethylene tubing SDR-9 CTS - OD - ASTM-2666 & ASTM-2737 dimensions.

Tubing Size	Nominal OD	Nominal ID	Pressure Rating - PSI
3/4"	0.875	0.675	160
1"	1.125	0.865	160
1 1/4"	1.375	1.059	160
1 1/2"	1.625	1.253	160
2"	2.125	1.629	160



NSF LISTED SE-14: ALL Compression fittings are listed by the National Sanitation Foundation as acceptable for use with potable water.



710 Series

NSF61 Annex G

UPC



730 Series

UPC



731 Series

NSF61 Annex G



733 Series

NSF61 Annex G

UPC

©Insert stiffener supplied must be used with this fitting

Part Number	Tube Size	Description	Length	Ctn Qty
PVC Couplings, ts x ts				
710-07	3/4"	3/4" x 3/4"	4"	35
710-10	1"	1" x 1"	4"	24
710-17	1"	SDR9 x 3/4" SDR11	4"	36
710-12	1 1/4"	1 1/4" x 1 1/4"	4 1/2"	15
710-15	1 1/2"	1 1/2" x 1 1/2"	5"	15
710-20 ☺	2"	2" x 2"	5"	12
PVC Male Adapters, mipt x ts				
730-07	3/4"	3/4" x 3/4"	2 5/8"	25
730-10	1"	1" x 1"	2 7/8"	18
730-15	1 1/2"	1 1/2" x 1 1/2"	3 1/2"	18
730-20	2"	2" x 2"	3 1/2"	12
730-71	3/4" x 1"	3/4" x 1"	2 7/8"	18
PVC Female Adapters, fipt x ts				
731-07	3/4"	3/4" x 3/4"	2 5/8"	25
731-10	1"	1" x 1"	2 7/8"	15
731-12	1 1/4"	1 1/4" x 1 1/4"	2 7/8"	12
731-15	1 1/2"	1 1/2" x 1 1/2"	3 1/2"	18
731-20 ☺	2"	2" x 2"	4"	12
731-71	3/4" x 1"	3/4" x 1"	2 7/8"	15
PVC Spigot Adapters, ips spigot x ts, (For use with Sch 40 PVC tees, ells)				
733-07	3/4"	3/4" x 3/4"	2 7/8"	18
733-10	1"	1" x 1"	2 7/8"	18
733-12	1 1/4"	1 1/4" x 1 1/4"	2 7/8"	12
733-15	1 1/2"	1 1/2" x 1 1/2"	3 1/2"	18
733-20 ☺	2"	2" x 2"	3 1/2"	12
733-71	3/4" x 1"	3/4" x 1"	3 1/2"	18



www.cbsupplies.ca
Phone: (866) 503-5523 Fax: (888) 562-2095
AGI@cbsupplies.ca





118 Series



Flo Span Expandable Repair Coupling Features:

- Double EPDM o-ring seal gives more protection from possible leakage due to deflection of piston in the extended position.
- EPDM o-ring seal also protects against contamination on the cylinder wall.
- Solvent cement trap located in cap to capture excess solvent cement.
- Made from PVC type I grade I material meeting ASTM D-1784
- 118 Series does not have union end.

NEW			
Part Number	IPS Size	Body Length	Ctn Qty
PVC Flo-Span Expansion Couplings - NO UNION S x SPG			
118-05	1/2"	7 1/2"	28
118-07	3/4"	7 3/4"	24
118-10	1"	9 1/2"	15
118-12	1-1/4"	10 3/4"	10
118-15	1-1/2"	12 3/4"	16
118-20	2"	13 1/2"	12
118-25	2-1/2"	18 3/4"	3
118-30	3"	21"	3
118-40	4"	22 3/4"	3
QF-6000	6" S x S	26 1/4"	1



SW Series

Part Number	For Use with Coupling Sizes	Ctn Qty
Adjustable Strap Wrench		
SW400	1/2" through 4"	60
SW600	1/2" through 6"	60



Check Valves - Flo Control



PVC Spring Check Valve Features:

- To stop backflow and syphoning.
- All water applications.
- Maintenance free operation.
- Tapered valve body design & enlarged valve chamber reduces chatter & turbulence.
- Raised radius valve seat, EPDM Seal for positive seal.
- Stainless steel spring load of 1/2 lb. or 2 lb.
- Solvent weld or male and female thread connections.
- 200 P.S.I. static pressure rating @ 72° F.
- Excess solvent cement trap - Designed to help prevent excess cement or softened material from entering into the body and sealing area during installation.
- NSF61 Annex G approved.

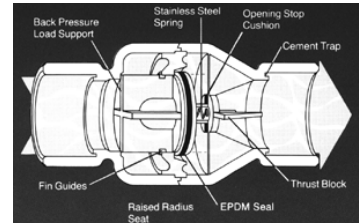

1001, 1011, 1012 Series

NSF61 Annex G



1011C Series

NSF61 Annex G



1800 Series

NSF61 Annex G

Part Number	IPS Size	Body Length	Ctn Qty
PVC Spring Check Valves (fipt x fipt)			Spring Tension 1/2 lb
1001-05	1/2"	4-1/8"	20
1001-07	3/4"	4-1/8"	20
1001-10	1"	5-1/4"	20
1001-12	1-1/4"	6-3/16"	15
1001-15	1-1/2"	6-3/16"	15
1001-20	2"	7"	10
PVC Spring Check Valves (slip x slip)			Spring Tension 1/2 lb
1011-05	1/2"	4-1/8"	20
1011-07	3/4"	4-1/8"	20
1011-10	1"	5-1/4"	20
1011-12	1-1/4"	6-3/16"	15
1011-15	1-1/2"	6-3/16"	15
1011-20	2"	7"	10
1011-25	2 1/2"		8
1011-30	3"		8
Clear			
1011C-15	1-1/2"	6-3/16"	10
1011C-20	2"	7"	10
PVC Spring Check Valve, (slip x slip)			Spring Tension 2 lbs.
1012-10	1"		20
1012-12	1-1/4"		15
1012-15	1-1/2"		15
1012-20	2"		10
Foot Valve Screen			
1800-07	3/4"	2-2/5"	1
1800-10	1"	2-4/5"	1
1800-12	1-1/4"	3"	1
1800-15	1-1/2"	3-2/5"	1
1800-20	2"	3-4/5"	1

Check Valves - Flo Control



PVC True Union Spring Check Valve Features:

- Designed for easy body removal.
- Tail pieces remain in place.
- 1/2 lb. psi spring tension. 2 lb. spring tension available by special order.
- EPDM seal and o-rings.
- 200 P.S.I. static pressure rating @ 72° F.
- Stainless steel spring.
- Excess solvent cement trap.
- NSF approved.

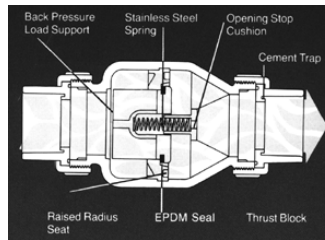

1700 Series

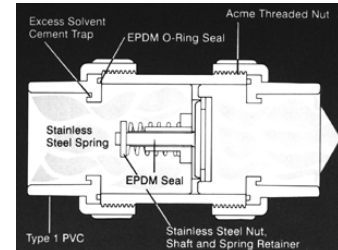

1790 Series



1700 Series



1700C Series

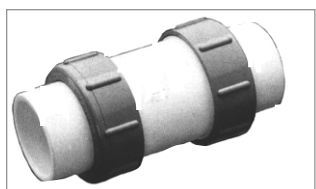

1790 Series



1790C Series

NSF61 Annex G

Part Number	Description	Body Length	Ctn Qty
True Union Spring Check Valves - WHITE			1/2# Spring Tension
1700-15	1 1/2" spring check	8.345"	12
1700-20	2" spring check	9.735"	12
True Union Spring Check Valves - CLEAR			1/2# Spring Tension
1700C-15	1 1/2" spring check	8.345"	12
1700C-20	2" spring check	9.735"	12
Compact True Union Spring Check Valves - WHITE			1/2# Spring Tension
1790-15	1 1/2" compact valve	6.54"	15
1790-20	2" compact valve	7.35"	10
Compact True Union Spring Check Valves - CLEAR			1/2# Spring Tension
1790C-15	1 1/2" compact valve	6.54"	15
1790C-20	2" compact valve	7.35"	10





Check Valves - Flo Control

PVC Adjustable Spring Check Valve Features:

- Use to restrain pressure in elevated pipelines.
- Ideal for preventing syphoning.
- Male or female threaded connection.
- 200 psi static pressure rating @ 72 °F.
- Adjustable from 5 lb to 15 lb spring tension to retain a column of water 12 to 36 foot head.
- EPDM seal.
- NSF61 Annex G approved.

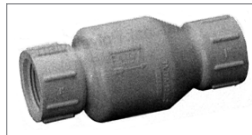
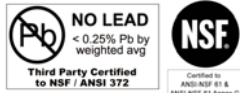
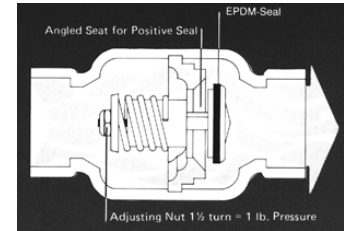

1205 Series

NSF61
Annex G



1235 Series

NSF61
Annex G

Part Number	IPS Size	Body Length	Ctn Qty
PVC Adjustable Spring Check Valves (fipt x fipt)			Spring Tension 5 lb
1205-05	1/2"	4-1/8"	20
1205-07	3/4"	4-1/8"	20
1205-10	1"	5-1/4"	20
1205-12	1-1/4"	6-3/16"	15
1205-15	1-1/2"	6-3/16"	15
PVC Adjustable Spring Check Valves (fipt x mipt)			Spring Tension 5 lb
1235-05	1/2"	4-1/8"	20
1235-07	3/4"	4-1/8"	20
1235-10	1"	5-1/4"	20

PVC SUMP CHECK Valve Features:

- Positive seal with long lasting EPDM weighted flapper and Buna-N gaskets.
- Easy installation and removal with compression seal connections. No hose clamps, cementing or threading necessary
- Allows 1 3/4" vertical movement of discharge pipe for easy removal of pump.
- Unitized body construction using spin welded process with permanent interlock of Buna-N flapper.
- Valve fits either 1 1/4" or 1 1/2" IPS size. Gaskets for both provided with each valve.
- Sump pumps with larger volume output use 1500 or 1520 series swing check. (see next page)
- Rated at 125 psi @ 72 °F.

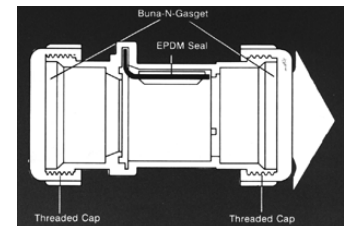

SUMP CHECK

Part Number	IPS Size	Body Length	Ctn Qty	List Price
PVC Sump Check Valve				
BUNA-N gaskets are included for both the 1 1/4" and 1 1/2" applications				
SUMP CHECK	1-1/4"-1-1/2"	5 1/4"	12	



Check Valves - Flo Control



PVC Swing Check Valve Features:

- No metallic parts, corrosion resistant..
- Full flow design.
- Angle seat and weighted flapper designed for low pressure seal.
- PVC weighted and shielded flapper will retain backpressure up to 125 psi.
- Iron pipe sized 1/2" - 4".
- Compression style for IPS sized plastic or metal pipe 1 1/4" - 3"
- Ideal for close working areas, easy pipe alignment.
- Compression ends can be used as union connections.
- Designed for both horizontal and vertical use.
- Pressure rated 125 psi @ 72° F.
- NSF approved.

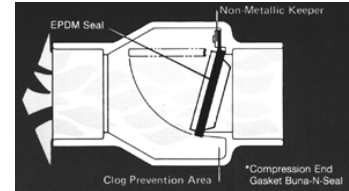

1500 Series

NSF61
Annex G



1520 Series

NSF61
Annex G



1520C Series



1720 Series



1720C Series

Part Number	IPS Size	Body Length	Ctn Qty
PVC Swing Check Valve - WHITE comp x comp			
1500-12	1-1/4"	7-1/2"	12
1500-15	1-1/2"	7-1/2"	12
1500-20	2"	9-3/4"	12
1500-30	3"	14"	2
PVC Swing Check Valve - CLEAR comp x comp			
1500C-15	1-1/2"	7-1/2"	5
1500C-20	2"	9-3/4"	8
PVC Swing Check Valve - WHITE slip x slip			
1520-05	1/2"	4-1/2"	25
1520-07	3/4"	4-1/2"	25
1520-10	1"	5-1/8"	25
1520-12	1-1/4"	5-1/4"	12
1520-15	1-1/2"	5-3/4"	12
1520-20	2"	6"	12
1520-30	3"	9"	4
1520-40	4"	9-1/2"	4
PVC Swing Check Valve - CLEAR slip x slip			
1520C-10	1"	5-1/8"	1
1520C-12	1-1/4"	5 1/4"	1
1520C-15	1-1/2"	5 3/4"	12
1520C-20	2"	6"	12
True Union Swing Check Valves - WHITE slip x slip			
1720-15	1 1/2"		12
1720-20	2"		12
True Union Swing Check Valves - CLEAR BODY, WHITE NUTS/TAILS slip x slip			
1720C-10	1"		20
1720C-15	1 1/2"		12
1720C-20	2"		12
1720C-30	3"		20



Check Valves - Flo Control



2200 Series

2200 Series Checkmate Features:

- One piece ball/check valve combination.
- Save time, labor and hassle to applications requiring in-line ball valves and check valves.
- True union or compression design allows for removal of check valve for cleaning or repairs.
- Rates at 125 psi. May be installed in vertical or horizontal position.
- Made of PVC type 1 grade 1 material meeting ASTM-D1784.

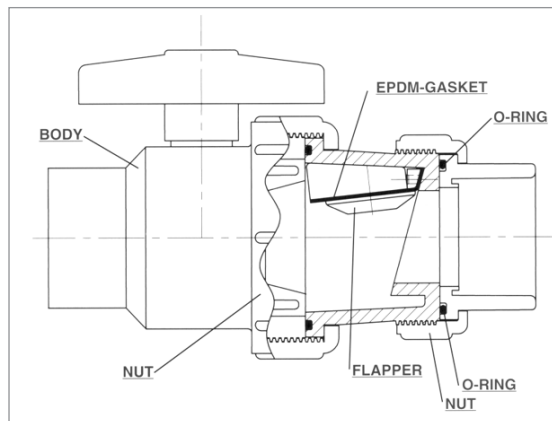

Part Number	Description	Ctn Qty
2200-15	1 1/2" Union x Slip	12
2200-20	2" Union x Slip	12
2200-15TU	1 1/2" Union x Union	12
2200-20TU	2" Union x Union	12
2200-15UC	1 1/2" Compression x Compression	12
2200-20UC	2" Compression x Compression	12

Diverter Valves, Sch 40 White Unions

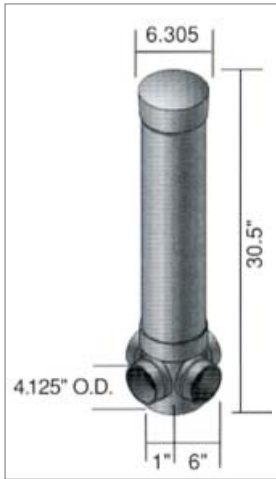

575 Series

Diverter Valve Features:

- For septic tank leach fields.
- Made of tough molded plastic that will not shatter, bend, rust or corrode.
- Light in weight, easier to handle and less expensive to ship.
- Stem flow may be controlled to individual or up to 3 fields in any combination. With a 3-way stem, flow may be diverted to any two outlets. To allow flow through all outlets, the valve stem may be removed from the assembly.
- ABS is IAPMO listed.

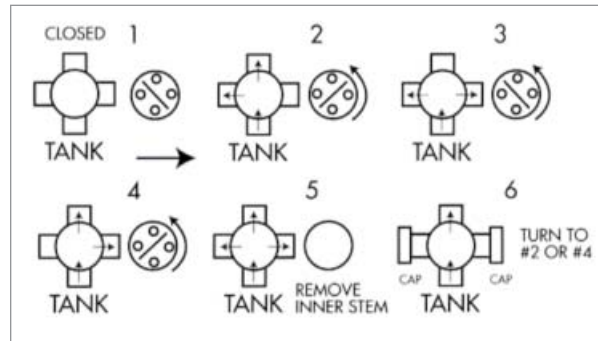

Part Number	Description	Ctn Qty
575	4" ABS Diverter Valve, Black	4
575P	4" PVC Diverter Valve, White	4

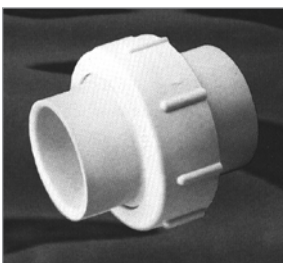

1600 Series



Part Number	IPS Size	Ctn Qty
SCHEDULE 40 - MADE IN USA		
SLIP X SLIP		
1600-15	1 1/2" Socket both ends, 2" spigot one end	24
1600-20	2" Socket both ends, 2 1/2" spigot one end	20





Check Valves - PVC Spa, By-Pass



1050 Series



PVC Spa Air Valve Features:

- Drip proof seal at low pressure.
- 1 1/2" IPS deep socket connection with 2" IPS OD spigot
- Excess solvent cement trap at base of socket to help prevent solvents from entering sealing area.
- Minimum restriction of air flow, using 1/4 lb. spring resulting in less burden on blower motor.
- Domed shaped seat for even air flow.
- EPDM seal.
- Stainless steel spring.
- NSF approved.

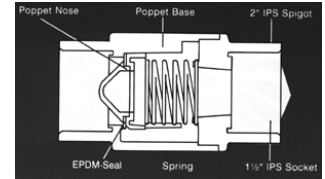

1095 Series

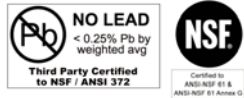

PVC In-Line By-Pass Check Valve Features:

- In-line shape takes less space.
- Raised valve seat prevents excess cement of solvent from affecting the seal area.
- Poppet is equipped with EPDM seal.
- Body is made of Type 1 PVC.
- All metal parts are stainless steel.
- Valve stem is reinforced w/ full length stainless steel shaft.
- Static pressure tested: 150 psi @ 72 °F. Back pressure tested at 150 psi.
- Quick burst test proves in excess of 500 psi
- 2" iron pipe size
- Valve can be used on 1-1 1/2" pipe by use of a PVC Sch 40 bushing.
- Begins to open 5 lbs - Fully open 17 lbs.
- NSF61 Annex G approved.

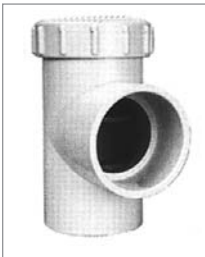
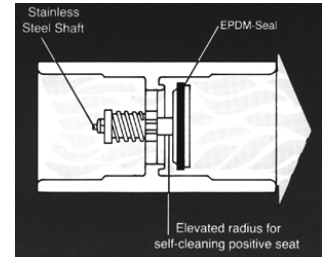

1901/1903 Series

CPVC 90° Spring Check Valve Features:

- Use in pool, spa applications.
- CPVC body with corrosion proof poppet.
- Spring made of 302 stainless.
- Available with 1 lb. or 3 lb. spring tension.
- NSF approved.

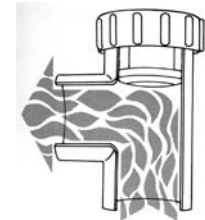

Part Number	IPS Size	Body Length	Ctn Qty
PVC Spa Air Valve - 1-1/2" ips socket / 2" ips o.d. spigot			
1050-20	2"	5-1/8"	12
PVC In Line By-Pass Check Valve			
1095-20	2" w/ 5# spring	5"	12
CPVC 90° Spring Check Valve, w/ stainless steel poppet			
1901-15	1 1/2" check valve, 1 lb. tension		12
1903-15	1 1/2" check valve, 3 lb. tension		12
1901-20	2" socket x 2 1/2" spigot valve, 1 lb. tension		12
1903-20	1" socket x 2 1/2" spigot valve, 3 lb. tension		12



Valves - PVC Single Union, 3-way CPVC



1350 Series

PVC Single Union Ball Valve Features:



- PVC Type 1 construction for compatibility in joining rigid PVC and flex vinyl pipes.
- **Buna "N" O-Ring seal; HDPE seats.**
- 1-1/4 deep sockets on both ends for extra cementing surface area.
- Acme thread on assembly nut prevents cross threading.
- Tee handle for quarter turn on/off with stops.
- Working pressure: 150 PSI at 72°F, 100 PSI at 120°F.
- Threaded or socket.
- Made in USA.



Part Number	Threaded/Socket	Size	Ctn Qty
1350-15	Socket	1-1/2"	12
1350-20	Socket	2"	6
1351-15	Threaded	1-1/2"	12

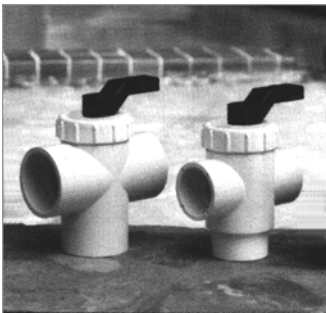

1930 Series

CPVC Three-Way Valve Features:

- For pool & spa applications.
- Made of CPVC plastic
- Diverts water anywhere diversion is required.
- Positive seal diverter prevents reverse flow.
- Diverter seals are made of a special lubricated EPDM material
- Available 1 1/2" - 2" slip with 2" and 2 1/2" spigot.
- Rated at 160° F, 125 PSI



Part Number	Description	Ctn Qty
1930-15	1 1/2" slip x 2" spigot	12
1930-20	2" slip x 2 1/2" spigot	12



Flo-Well® Storm Water Leaching System

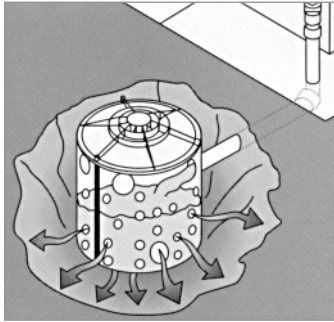

Flo-Well Storm Water Leaching System

- Discharge water into the subsoil rapidly and easily.
- No need for piping systems to transport stormwater to a far-off point, large heavy equipment, considerable excavation of current landscape areas or large labor costs that those systems incur.

Materials:

- Structural foam polyolefin with UV inhibitors.

Applications:

Flo-Well systems should be placed at least 10 feet from a structure or foundation.

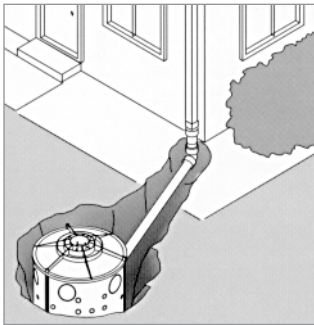

For gutters & downspouts

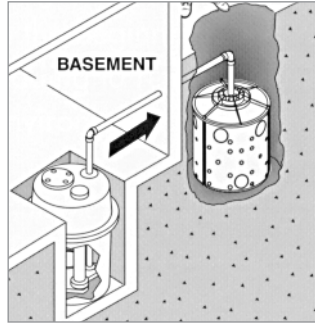

For sump pumps

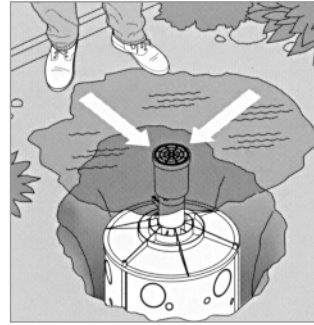

For low grade areas

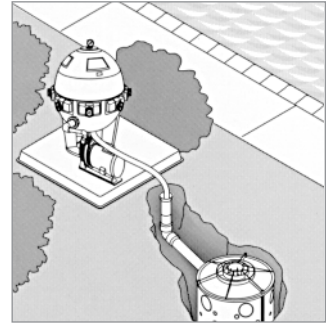

For pool backwash tanks

Options

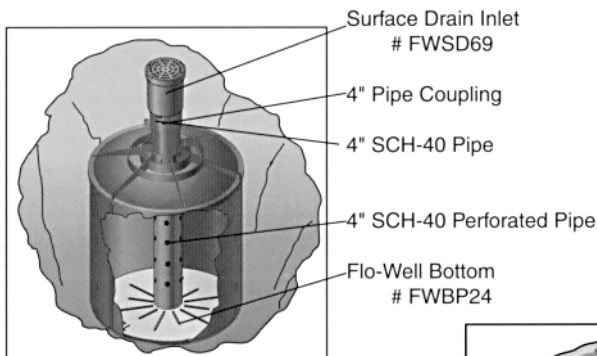

For additional support

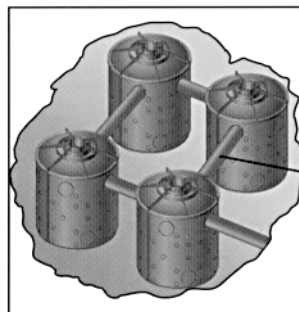

Can be connected

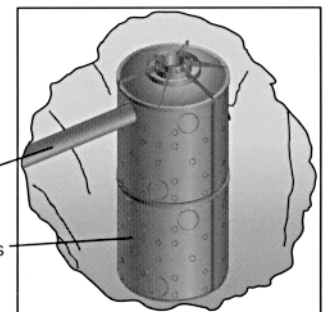

Can be stacked

4" SCH-40 Pipe

Flo-Well Side Panels #FWSPS3



www.cbsupplies.ca
 Phone: (866) 503-5523 Fax: (888) 562-2095
 AGI@cbsupplies.ca



Flo-Well® Storm Water Leaching System

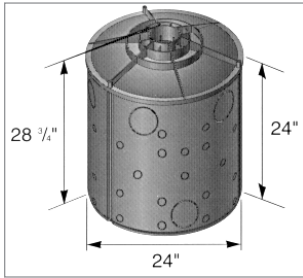

Flo-Well Storm water leaching system

- Includes 3 side panels, 1 top component
- 18 - 1 1/2" knockout leaching ports and 3 - 4 1/2" knockout inlet/outlet ports per panel.
- 49 gal capacity
- Fits 4" Sch 40 pipe and 4" DWV pipe

Part Number	Description	Color	Weight lbs.	Ctn Qty
FWAS24	24 x 28 3/4" round system	Black	25.15	1

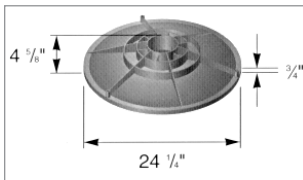

Flo-Well Cover

- Fits FWAS24 and FWSPS3

Part Number	Description	Color	Weight lbs.	Ctn Qty
FWAS24C	24" dia cover	Black	8.0	2

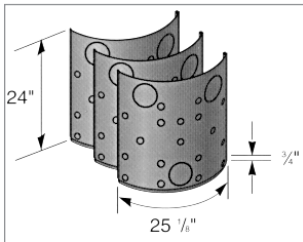

Flo-Well Side Panels/ Extension Only

- Includes 3 side panels, 24" high, with 3/4" lip for stacking.
- Fits FWSA24
- 18 - 1 1/2" knockout leaching ports and 3 - 4 1/2" knockout inlet/outlet ports per panel.

Part Number	Description	Color	Weight lbs.	Ctn Qty
FWSPS3	side panels	Black	5.0	1

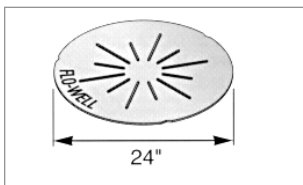

Flo-Well Bottom

- Six 1 1/2" leaching ports
- Fits FWAS24

Part Number	Description	Color	Weight lbs.	Ctn Qty
FWBP24	24" dia bottom	Black	3.5	5

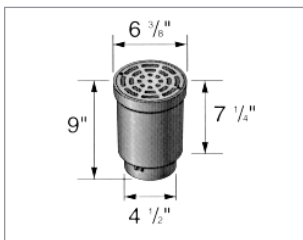

Flo-Well Surface Drain Inlet with Grate

- 6" grate with 4" inlet.
- Fits FWAS24 and FFWAS24C, PVC Sch 40 fittings

Part Number	Description	Color	Weight lbs.	Ctn Qty
FWSD69	4" Sch 40 Inlet	Black	1.85	8

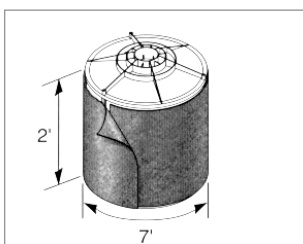

Porus Filter Fabric Wrap for FloWell

- 7' long x 2' wide to surround drywell system
- Non woven fabric
- Weight 1 oz. Mullen burst 175 psi, 200 gpm flow through.

Part Number	Description	Color	Weight lbs.	Ctn Qty
FWFF67	7' x 2' Porus Filter Fabric Wrap	Black	0.35	20



Catch Basins & Grates



Catch Basin & Grate Features:

- Eliminates standing water and flooding on paved areas and lawns.
- Easy to install, sized to fit your project with catch basins from 6" to 24" and grates from 2" to 24".
- Prohibits structural damage to building foundations.
- Choose from a wide variety of products to fit every need.

Materials and Standards:

- Ultraviolet-resistant one piece injection-molded structural foam polyolefin for maximum strength.
- Installed properly, some plastic grates are suitable for light vehicular traffic. Standards vary per product. See individual product section for details.

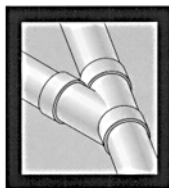
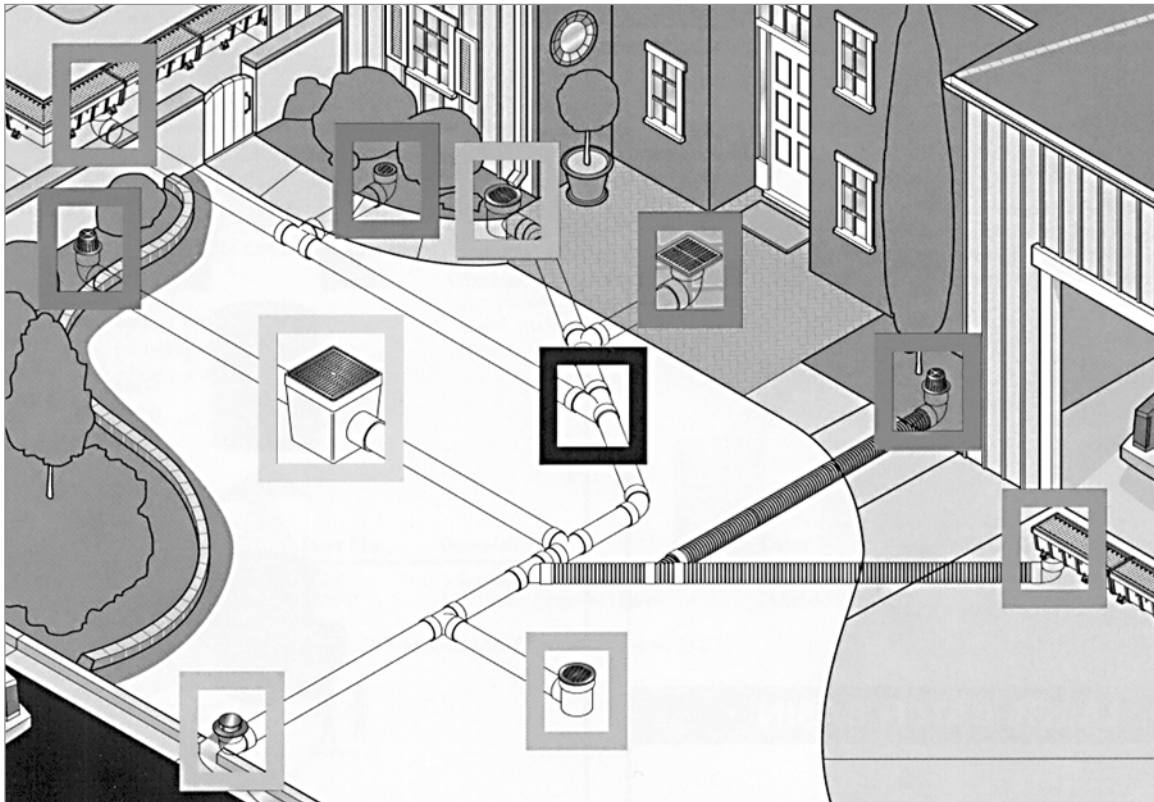

Sewer & Drain Fittings
for piping systems and downspouts.



Channel Drains
for driveways, pools, spas, patios, sidewalks and wash-down areas.



Large Catch Basins
for large lawn or landscape areas, residential driveways and garages.



Small Catch Basins
for lawn and landscape areas.



Small Grates
for small lawn and landscape areas, patios and atriums.

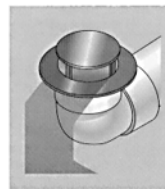

Pop-up Emitters
for discharging water on the surface.

Catch Basins & Grates



Flexible by Design

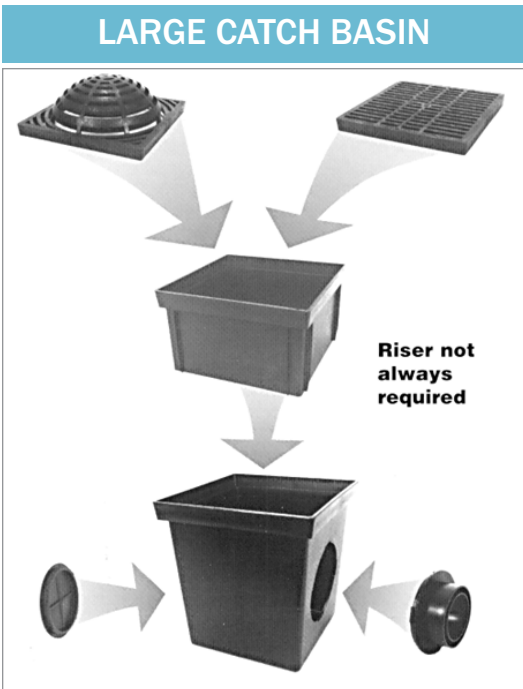
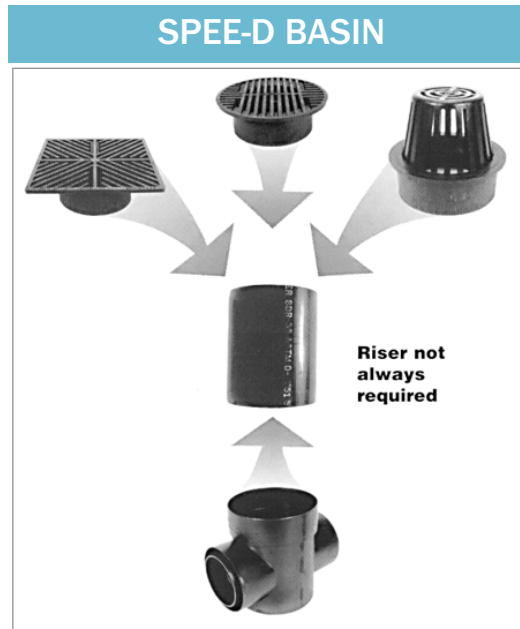

Load Recommendations:



Class A

- Loads of 1-60 psi.
- Recommended for pedestrians, bicycles and wheel chair traffic.



Class B

- Loads of 61-175 psi.
- Recommended for medium-duty pneumatic tire traffic, autos and light trucks at speeds less than 20 mph.



www.cbsupplies.ca
 Phone: (866) 503-5523 Fax: (888) 562-2095
 AGI@cbsupplies.ca





Spee-D Basins / Round Grates

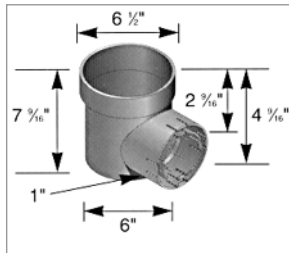

6" Spee-D Basin with 3" and 4" Locking Outlet

- Locking outlet snaps on to most 3" and 4" corrugated pipe.
- Outlets fit 3" or 4" sewer & drain pipe, corrugated pipe.

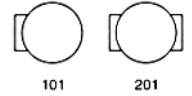

Part Number	Description	Color	Weight lbs.	Ctn Qty
101	1 - 3" and 4" locking outlet	Black	1.60	10
201	2 - 3" and 4" locking outlets	Black	1.90	10

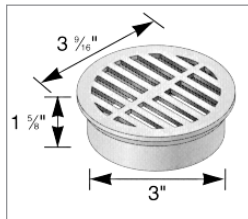

3" Round Grate

- 3" round structural foam polyolefin grate with UV inhibitor.
- Open surface area 2.6 sq. in.. 3.41 gpm
- 3/16" grate opening.
- Fits 3" sewer and drain pipe and fittings, corrugated pipe and triple wall pipe.



Part Number	Description	Color	Weight lbs.	Ctn Qty
14	3" round grate	Black	0.15	40
15	3" round grate	Gray	0.15	40
16	3" round grate	Green	0.15	40

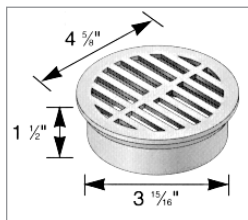

4" Round Grate

- 4" round structural foam polyolefin grate with UV inhibitor.
- Open surface area 3.85 sq. in.. 5.04 gpm
- 1/4" grate opening.
- Fits 4" sewer and drain pipe and fittings, corrugated pipe and triple wall pipe.



Part Number	Description	Color	Weight lbs.	Ctn Qty
11	4" round grate	Black	0.20	25
12	4" round grate	Gray	0.20	25
13	4" round grate	Green	0.20	25

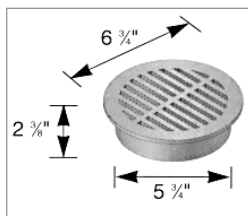

6" Round Grate

- 6" round structural foam polyolefin grate with UV inhibitor.
- Open surface area 9.10 sq. in.. 11.92 gpm
- 1/4" grate opening.
- Fits Spee-D basin, 6" sewer and drain pipe and fittings, corrugated pipe.



Part Number	Description	Color	Weight lbs.	Ctn Qty
40	6" round grate	Black	0.80	10
50	6" round grate	Green	0.80	10
60	6" round grate	Gray	0.80	10

AGI has access to the complete line of NDS drainage products. Contact customer sales for more information and pricing.



www.cbsupplies.ca
 Phone: (866) 503-5523 Fax: (888) 562-2095
 AGI@cbsupplies.ca



Round Grates

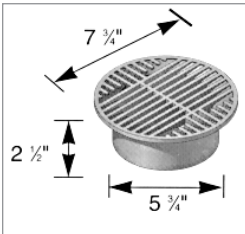

8" Round Grate

- 8" round structural foam polyolefin grate with UV inhibitor.
- Open surface area 11.50 sq. in.. 15.07 gpm
- 5/16" grate opening.
- Fits Spee-D basin, 6" sewer and drain pipe and fittings, corrugated pipe.



Part Number	Description	Color	Weight lbs.	Ctn Qty
10	8" round grate	Black	0.80	10
20	8" round grate	Green	0.80	10
30	8" round grate	Gray	0.80	10

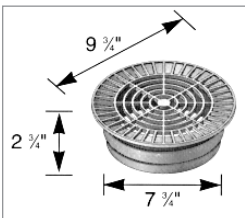

10" Round Grate

- 10" round structural foam polyolefin grate with UV inhibitor.
- Open surface area 17.46 sq. in.. 22.87 gpm
- 5/16" grate opening.
- Fits 8" sewer and drain pipe and fittings, corrugated pipe.



Part Number	Description	Color	Weight lbs.	Ctn Qty
1040	10" round grate	Black	1.50	10
1050	10" round grate	Green	1.50	10
1060 ☺	10" round grate	Gray	1.50	10

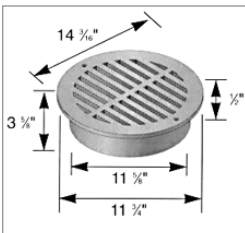

12" Round Grate

- 12" round structural foam polyolefin grate with UV inhibitor.
- Open surface area 46.00 sq. in.. 60.26 gpm
- 9/16" grate opening.
- Fits 12" sewer and drain pipe, corrugated pipe.



Part Number	Description	Color	Weight lbs.	Ctn Qty
1240	12" round grate	Black	3.35	6
1250	12" round grate	Green	3.35	6

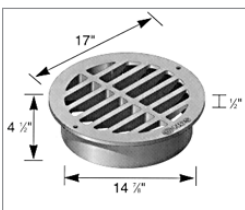

15" Round Grate

- 15" round structural foam polyolefin grate with UV inhibitor.
- Open surface area 85.60 sq. in.. 112.14 gpm
- 1 1/4" grate opening.
- Fits 15" sewer and drain pipe and fittings, corrugated pipe.



Part Number	Description	Color	Weight lbs.	Ctn Qty
1511	15" round grate	Black	6.15	1
1512	15" round grate	Green	6.15	1

☺ Non-stock item, available on a special order basis.

AGI has access to the complete line of NDS drainage products. Contact customer sales for more information and pricing.



www.cbsupplies.ca
 Phone: (866) 503-5523 Fax: (888) 562-2095
 AGI@cbsupplies.ca



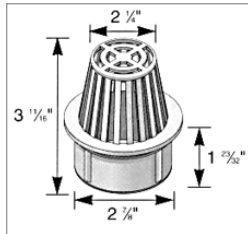

3" Atrium Grate

- 3" Flat top structural foam polyolefin atrium grate with UV inhibitor.
- Open surface area 9.5 sq. in.. 12.45 gpm
- 1/4" grate opening.
- Fits 3" sewer and drain pipe and fittings, corrugated pipe and triple wall pipe.

Part Number	Description	Color	Weight lbs.	Ctn Qty
70	3" atrium grate	Green	0.25	20
72 ☺	3" atrium grate	Gray	0.25	20
74	3" atrium grate	Black	0.25	20

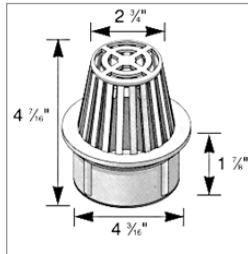

4" Atrium Grate

- 4" Flat top structural foam polyolefin atrium grate with UV inhibitor.
- Open surface area 14.5 sq. in.. 19.0 gpm
- 1/4" grate opening.
- Fits 4" sewer and drain pipe and fittings, corrugated pipe and triple wall pipe.

Part Number	Description	Color	Weight lbs.	Ctn Qty
75	4" atrium grate	Green	0.30	20
76 ☺	4" atrium grate	Gray	0.30	20
78	4" atrium grate	Black	0.30	20

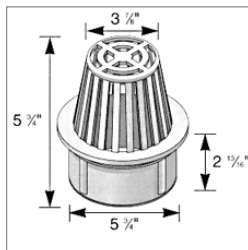

6" Atrium Grate

- 6" Flat top structural foam polyolefin atrium grate with UV inhibitor.
- Open surface area 25.5 sq. in.. 33.41 gpm
- 1/4" grate opening.
- Fits Spee-D basin, 6" sewer and drain pipe and fittings, corrugated pipe.

Part Number	Description	Color	Weight lbs.	Ctn Qty
80	6" atrium grate	Green	0.70	10
81 ☺	6" atrium grate	Gray	0.70	10
90	6" atrium grate	Black	0.70	10

☺ Non-stock item, available on a special order basis.

AGI has access to the complete line of NDS drainage products. Contact customer sales for more information and pricing.

Square Grates

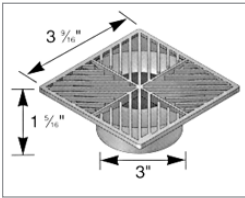

4" Square Grate

- 4" square structural foam polyolefin grate with diagonally converging pattern with UV inhibitor.
- Open surface area 3.45 sq. in.. 4.52 gpm
- 3/16" grate opening.
- Fits 3" sewer & drain pipe and fittings, corrugated pipe and triple wall pipe.



Part Number	Description	Color	Weight lbs.	Ctn Qty
01	4" square grate	Green	0.11	40
02	4" square grate	Black	0.11	40

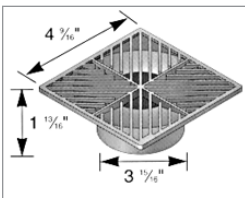

5" Square Grate

- 5" square structural foam polyolefin grate with diagonally converging pattern with UV inhibitor.
- Open surface area 4.25 sq. in.. 5.57 gpm
- 3/16" grate opening.
- Fits 4" sewer & drain pipe and fittings, corrugated pipe and triple wall pipe.



Part Number	Description	Color	Weight lbs.	Ctn Qty
07	5" square grate	Green	0.20	25
08	5" square grate	Black	0.20	25

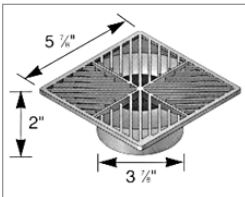

6" Square Grate

- 6" square structural foam polyolefin grate with diagonally converging pattern with UV inhibitor.
- Open surface area 10.40 sq. in.. 13.62 gpm
- 1/4" grate opening.
- Fits 3" or 4" sewer & drain pipe, corrugated pipe and triple wall pipe.



Part Number	Description	Color	Weight lbs.	Ctn Qty
04	6" square grate	Black	0.40	10
05	6" square grate	Green	0.40	10

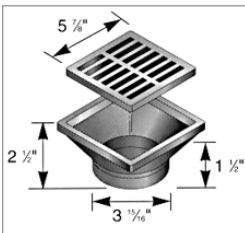

6" x 6" x 4" Square Grate and Adapter

- 6" x 6" low profile adapter and structural foam polyolefin removable grate with UV inhibitor & stainless steel screws.
- Open surface area 13.61 sq. in.. 17.83 gpm
- 1/4" grate opening.
- Fits 3" or 4" sewer & drain pipe and fittings, corrugated pipe and triple wall pipe.



Part Number	Description	Color	Weight lbs.	Ctn Qty
640	6" x 6" x 4" square grate & adapter	Black	0.88	8
641	6" x 6" x 4" square grate & adapter	Green	0.88	8

AGI has access to the complete line of NDS drainage products. Contact customer sales for more information and pricing.



www.cbsupplies.ca
 Phone: (866) 503-5523 Fax: (888) 562-2095
 AGI@cbsupplies.ca





Square Grates

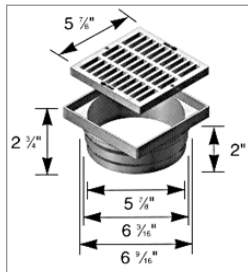

6" x 6" x 6" Square Grate and Adapter

- 6" x 6" low profile adapter and structural foam polyolefin removable grate with UV inhibitor & stainless steel screws.
- Open surface area 13.61 sq. in.. 17.83 gpm
- 1/4" grate opening.
- Fits Spee-D basin, 6" sewer & drain pipe and fittings.



Part Number	Description	Color	Weight lbs.	Ctn Qty
637	6" x 6" x 6" square grate & adapter	Black	0.88	8
639	6" x 6" x 6" square grate & adapter	Gray	0.88	8

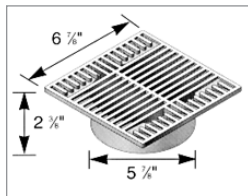

7" Square Grate

- 7" square structural foam polyolefin grate with UV inhibitor.
- Open surface area 13.60 sq. in.. 17.83 gpm
- 1/4" grate opening.
- Fits Spee-D basin, 6" sewer & drain pipe and fittings, corrugated pipe.



Part Number	Description	Color	Weight lbs.	Ctn Qty
771	7" square grate	Black	0.70	10
772	7" square grate	Green	0.70	10
773	7" square grate	Gray	0.70	10

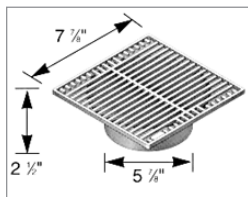

8" Square Grate

- 8" square structural foam polyolefin grate with UV inhibitor.
- Open surface area 17.16 sq. in.. 22.48 gpm
- 1/4" grate opening.
- Fits Spee-D basin, 6" sewer & drain pipe and fittings, corrugated pipe.



Part Number	Description	Color	Weight lbs.	Ctn Qty
881	8" square grate	Black	0.80	10
882	8" square grate	Green	0.80	10

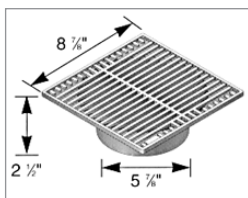

9" Square Grate

- 9" square structural foam polyolefin grate with UV inhibitor.
- Open surface area 28.40 sq. in.. 37.20 gpm
- 5/16" grate opening.
- Fits Spee-D basin, 6" sewer & drain pipe and fittings, corrugated pipe.



Part Number	Description	Color	Weight lbs.	Ctn Qty
950	9" square grate	Green	1.90	10
960	9" square grate	Gray	1.90	10

AGI has access to the complete line of NDS drainage products. Contact customer sales for more information and pricing.



www.cbsupplies.ca
 Phone: (866) 503-5523 Fax: (888) 562-2095
 AGI@cbsupplies.ca



9" Catch Basin Series

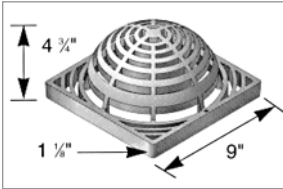

9" Catch Basin Atrium Grate

- 9" structural foam polyolefin dome atrium grate with UV inhibitor.
- Open surface area 30.28 sq in.. 39.67 gpm.
- 3/8" grate opening.
- Use with 9" x 9" catch basin series.

Part Number	Description	Color	Weight lbs.	Ctn Qty
981	9" x 9" atrium grate	Black	0.87	6
991	9" x 9" atrium grate	Green	0.87	6

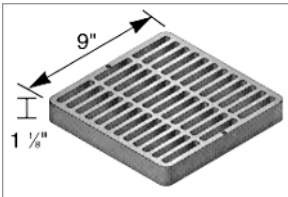

9" Catch Basin Square Grate

- 9" square structural foam polyolefin grate with UV inhibitor.
- Open surface area 39.50 sq in.. 51.75 gpm.
- 7/16" grate opening.
- Use with 9" x 9" catch basin series.



Part Number	Description	Color	Weight lbs.	Ctn Qty
980	9" x 9" square grate	Black	1.50	8
990	9" x 9" square grate	Green	1.50	8
999	9" x 9" square grate	Gray	1.50	8

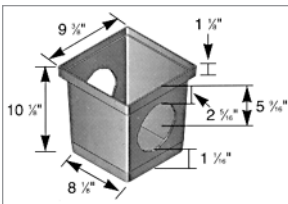

9" x 9" Tapered Catch Basin

- Requires universal outlet (1206, 1242, 1243, 1245, 1266 or 1889) for each opening.
- 900BLKIT includes 2 opening basin and black grate in a kit.

Part Number	Description	Color	Weight lbs.	Ctn Qty
900	9" x 9" catch basin 2-opening	Black	3.00	4
900-4	9" x 9" catch basin 4-opening	Black	2.00	4
900BLKIT	9" x 9" catch basin with black grate	Black	4.25	4

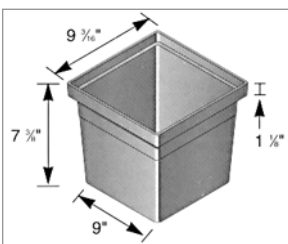

6" Riser for 9" x 9" Catch Basin

- Bottomless
- Use with 9" x 9" catch basin series

Part Number	Description	Color	Weight lbs.	Ctn Qty
916	9" x 9" catch basin riser	Black	1.75	4

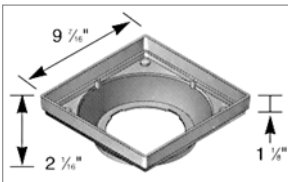

9" x 9" Low Profile Adapter

- Bayonet bottom outlet.
- Requires universal outlet (1243, 1245, 1266, 1889).
- Fits corrugated, sewer and drain pipe.

Part Number	Description	Color	Weight lbs.	Ctn Qty
930	9" x 9" low profile adapter	Black	0.75	8

AGI has access to the complete line of NDS drainage products. Contact customer sales for more information and pricing.



www.cbsupplies.ca
 Phone: (866) 503-5523 Fax: (888) 562-2095
AGI@cbsupplies.ca





12" Catch Basin Series

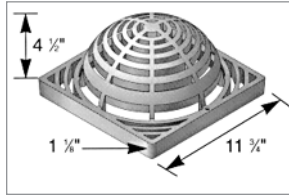

12" x 12" Atrium Grate

- 12" structural foam polyolefin dome atrium grate with UV inhibitor.
- Open surface area 60.00 sq. in.. 78.60 gpm.
- 3/8" grate opening.
- Use with 12" x 12" catch basin series.

Part Number	Description	Color	Weight lbs.	Ctn Qty
1280	12" x 12" atrium grate	Green	2.00	8
1290	12" x 12" atrium grate	Black	2.00	8

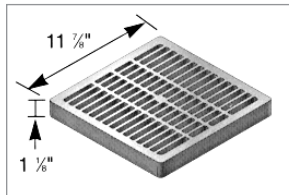

12" x 12" Square Grate

- 12" square structural foam polyolefin grate with UV inhibitor or heavy duty cast iron.
- Open surface area 50.76 sq. in. 66.50 gpm.
- Cast Iron open surface area 59.5 sq. in.. 77.95 gpm.
- 3/8" grate opening.
- Use with 12" x 12" catch basin series.



Part Number	Description	Color	Weight lbs.	Ctn Qty
1210	12" x 12" square grate	Gray	2.00	8
1211	12" x 12" square grate	Black	2.00	8
1212	12" x 12" square grate	Green	2.00	8
1213	12" x 12" Cast Iron square grate	Black	7.00	1

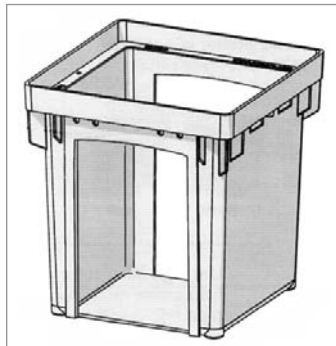

1200NB

Next Generation Catch Basin

- Adjustable height inlet and outlets; just snap off slide tabs.
- Kit includes catch basin with 2 open slides.
- Faster and easier to install.

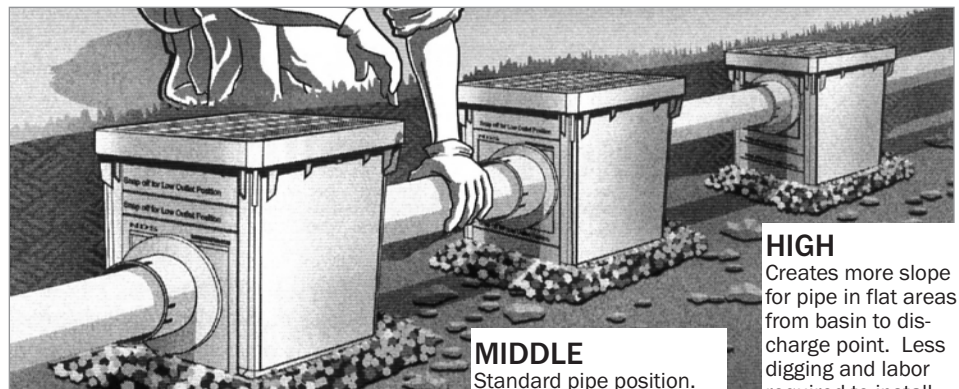

LOW

Reduces standing water in the bottom of the basin, especially in clay soils where water won't drain out of the bottom.

MIDDLE

Standard pipe position. Pipe inlet/outlet connects to the middle of the basin.

HIGH

Creates more slope for pipe in flat areas from basin to discharge point. Less digging and labor required to install pipe.

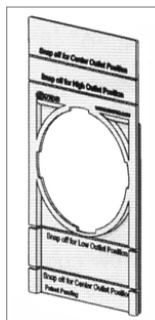

1207

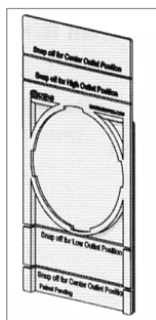

1208

Part Number	Description	Color	Weight lbs.	Ctn Qty
1200NBKIT	12" catch basin kit w/ 2 slides	Black	4.65	4
1200NB	12" catch basin	Black	3.45	4
1207	Open Slide for 1200NB	Black	.60	8
1208	Plug Slide for 1200NB	Black	.76	8



12" Catch Basin Series

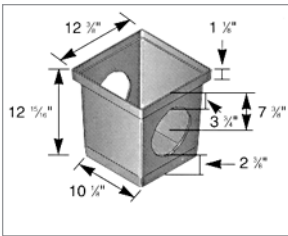

12" x 12" Tapered Catch Basin

- Requires universal outlet (1206, 1242, 1243, 1245, 1266, or 1889) for each opening.
- Use bottom cutout for additional outlet.
- 1200BLKIT includes 2 opening basin and black grate in a kit.

Part Number	Description	Color	Weight lbs.	Ctn Qty
1200	12" x 12" catch basin 2-opening	Black	4.25	4
1203	12" x 12" catch basin 3-opening	Black	3.75	4
1204	12" x 12" catch basin 4-opening	Black	3.75	4
1200BLKIT	12" x 12" catch basin with black grate	Black	8.00	4

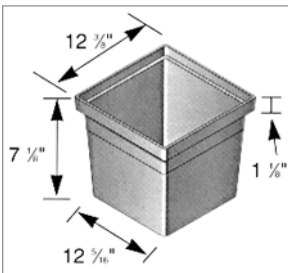

6" Riser for 12" x 12" Catch Basin

- Bottomless
- Use with 12" x 12" catch basin series

Part Number	Description	Color	Weight lbs.	Ctn Qty
1216	12" x 12" catch basin riser	Black	2.75	8

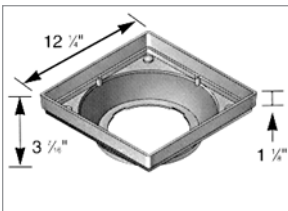

12" x 12" Low Profile Adapter

- Bayonet bottom outlet
- Requires universal outlet for connection to 3", 4" or 6" sewer and drain or corrugated pipe.

Part Number	Description	Color	Weight lbs.	Ctn Qty
1230	12" x 12" low profile adapter	Black	1.25	5

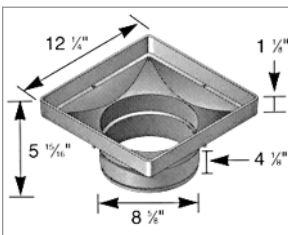

12" x 12" Square Low Profile Adapter

- Fits 8" sewer and drain pipe
- Use with #1222 spigot adapter to adapt to 8" corrugated pipe.

Part Number	Description	Color	Weight lbs.	Ctn Qty
1221	12" x 12" low profile adapter	Black	1.92	12
1222	12" x 12" low profile spigot adapter	Black	1.92	12

AGI has access to the complete line of NDS drainage products. Contact customer sales for more information and pricing.



www.cbsupplies.ca
 Phone: (866) 503-5523 Fax: (888) 562-2095
 AGI@cbsupplies.ca





18" Catch Basin Series

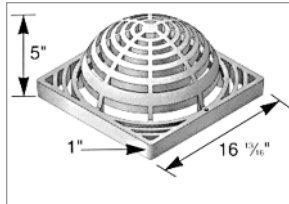

18" x 18" Atrium Grate

- 18" structural foam polyolefin dome atrium grate with UV inhibitor.
- Open surface area 64.51 sq. in.. 84.51 gpm.
- 1/2" grate opening.
- Use with 18" x 18" catch basin series.

Part Number	Description	Color	Weight lbs.	Ctn Qty
1881	18" x 18" atrium grate	Black	3.50	4
1891	18" x 18" atrium grate	Green	3.50	4

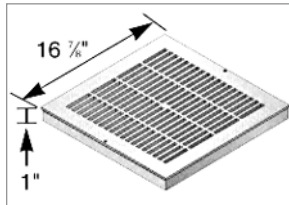

18" x 18" Square Grate

- 18" square structural foam polyolefin grate with UV inhibitor.
- Open surface area 104.00 sq. in.. 136.24 gpm.
- 7/16" grate opening.
- Use with 18" x 18" catch basin series.



Part Number	Description	Color	Weight lbs.	Ctn Qty
1810	18" x 18" square grate	Gray	5.50	4
1811	18" x 18" square grate	Black	5.50	4
1812	18" x 18" square grate	Green	5.50	4

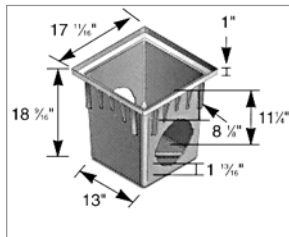

18" x 18" One Piece Tapered Catch Basin

- Requires universal outlet for each opening.
- Includes 2 or 4 #1890 reducing rings.

Part Number	Description	Color	Weight lbs.	Ctn Qty
1882	18" 1 piece catch basin 2-openings	Black	10.00	4
1884	18" 1 piece catch basin 4-openings	Black	9.50	4

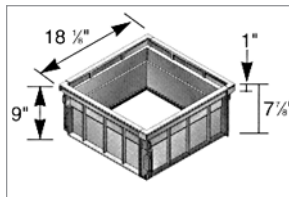

8" Riser for 18" x 18" Catch Basin

- Use with 18" one piece or expandable catch basins.
- 7 7/8" nesting height.
- Assembly required. Includes 4 riser sides.
- **NOTE:** Use roof tar or silicone to seal joints.

Part Number	Description	Color	Weight lbs.	Ctn Qty
1816	8" catch basin riser	Black	6.00	1

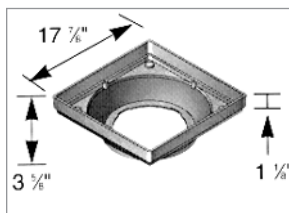

18" x 18" Low Profile Adapter

- Bayonet bottom outlet.
- Includes #1890 reducer ring.
- Requires universal outlet (1243, 1245, 1266, or 1888).
- Fits corrugated pipe and sewer and drain pipe.

Part Number	Description	Color	Weight lbs.	Ctn Qty
1830	18" x 18" low profile adapter	Black	4.75	4

AGI has access to the complete line of NDS drainage products. Contact customer sales for more information and pricing.



www.cbsupplies.ca
 Phone: (866) 503-5523 Fax: (888) 562-2095
 AGI@cbsupplies.ca



24" Catch Basin Series

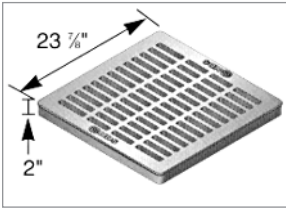

24" x 24" Square Grate

- 24" square structural foam polyolefin grate with UV inhibitor.
- Open surface area 231.69 sq. in.. 303.51 gpm.
- 7/8" grate opening.
- Use with 24" x 24" catch basin series.



Part Number	Description	Color	Weight lbs.	Ctn Qty
2411	24" x 24" square grate	Black	9.00	4
2412	24" x 24" square grate	Green	9.00	4

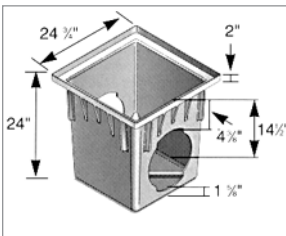

24" x 24" One Piece Tapered Catch Basin

- Requires 2 or 4 #2410 universal outlets.

Part Number	Description	Color	Weight lbs.	Ctn Qty
2400	24" 1 piece catch basin 2-opening	Black	18.00	4
2404	24" 1 piece catch basin 4-opening	Black	15.00	4

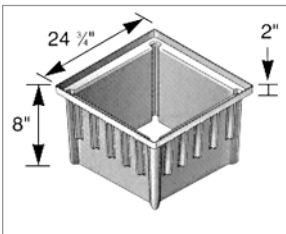

8" Extension for 24" x 24" Catch Basin

- Bottomless
- Use with 24" x 24" catch basin series

Part Number	Description	Color	Weight lbs.	Ctn Qty
2418	24"x 24" catch basin extension	Black	14.00	10

AGI has access to the complete line of NDS drainage products. Contact customer sales for more information and pricing.



www.cbsupplies.ca
 Phone: (866) 503-5523 Fax: (888) 562-2095
 AGI@cbsupplies.ca





Catch Basin Universal Outlets

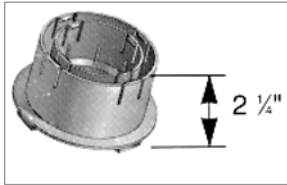

3" and 4" Universal Locking Outlet

- New locking outlet snaps on to most 3" and 4" corrugated pipe.
- Fits 3" & 4" corrugated pipe and sewer & drain pipe and triple wall pipe, 4" sch 40 pipe.
- Use with 9", 12" 18" and 24" (with #2410) catch basin series and adapters.

Part Number	Description	Color	Weight lbs.	Ctn Qty
1243	3" & 4" universal locking outlet	Black	0.70	20

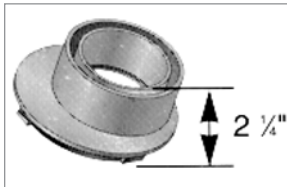

3" and 4" Offset Universal Outlet

- Fits 3" & 4" corrugated pipe and sewer & drain pipe, 4" sch 40 pipe and triple wall pipe.
- Allows for adjustable inlet height.
- Use with 9", 12", 18" and 24" (with #2410) catch basin series.

Part Number	Description	Color	Weight lbs.	Ctn Qty
1245	3" & 4" offset universal outlet	Black	0.55	20

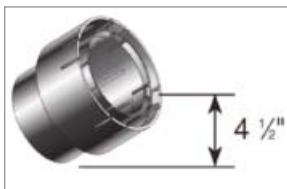

3" and 4" Universal Adapter w/ 4" spigot

- Fits 3" & 4" corrugated pipe, sewer & drain pipe, triple wall pipe and 4" sch 40 pipe.
- Use with 3" and 4" sewer and drain fittings.

Part Number	Description	Color	Weight lbs.	Ctn Qty
1241	3" & 4" universal adapter	Black	0.70	20

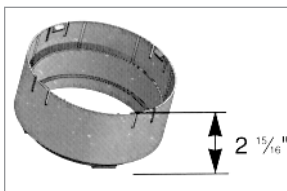

6" Universal Locking Outlet

- New locking outlet snaps on to most 3" and 4" corrugated pipe.
- Fits 6" corrugated pipe and sewer & drain pipe.
- Use with 9", 12", 18" and 24" (with #2410) catch basin series and adapters.

Part Number	Description	Color	Weight lbs.	Ctn Qty
1266	6" universal locking outlet	Black	0.75	20

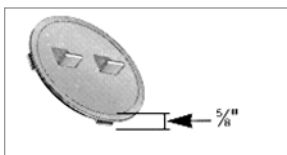

6" Universal Plug Adapter

- Use with 9", 12", 18" and 24" (with #2410) catch basin series.

Part Number	Description	Color	Weight lbs.	Ctn Qty
1206	6" universal plug adapter	Black	0.35	20

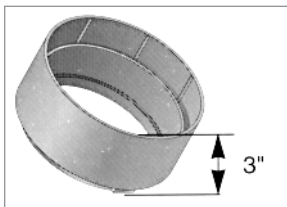

8" Universal Outlet

- Fits 8" corrugated pipe and sewer & drain pipe.
- Use with 18" and 24" (with #2410) catch basin series.

Part Number	Description	Color	Weight lbs.	Ctn Qty
1888	8" universal outlet	Black	1.25	8

AGI has access to the complete line of NDS drainage products. Contact customer sales for more information and pricing.



www.cbsupplies.ca
 Phone: (866) 503-5523 Fax: (888) 562-2095
 AGI@cbsupplies.ca



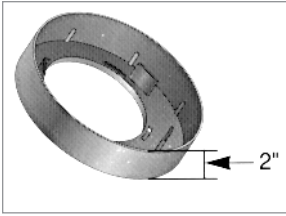

8" Offset Universal Adapter

- Fits 8" corrugated pipe and sewer & drain pipe.
- Use with 12" catch basin series.
- Use with #1890 reducer ring for 18" catch basin series.
- Reducer ring required on #1821 basin side, 18" catch basin series to adapt to universal outlets (#1206, 1243, 1245, 1266 or 1889.)

Part Number	Description	Color	Weight lbs.	Ctn Qty
1889	8" offset universal outlet	Black	0.80	10
1890	Universal outlet reducer ring	Black	0.50	8

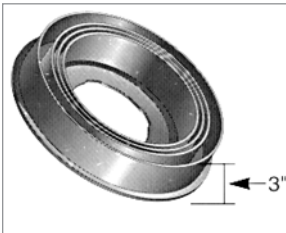

10" and 12" Universal Adapter

- Includes universal outlet reducer ring (#1890).
- Fits 10" and 12" corrugated pipe and sewer & drain pipe.
- Fits 3", 4", 6" and 8" corrugated, sewer & drain pipe, 4" Sch. 40 pipe by using corresponding adapter.
- Use with 24" catch basins.

Part Number	Description	Color	Weight lbs.	Ctn Qty
2410	10" and 12" universal adapter	Black	5.50	2



Swivel Fitting



4PVAF

Swivel Fit® Variable Angle Fitting

- Multiple fittings in one. Can be set and locked in place to any angle from 0° to 90°.
- Convenient for misaligned pipes and routing around corners and obstacles.
- Patent pending design.
- Installs in 3 easy steps.
- Fits 4" drain pipe SDR-35, Triple wall and ASTM-D2729.
- Not for sewer use.

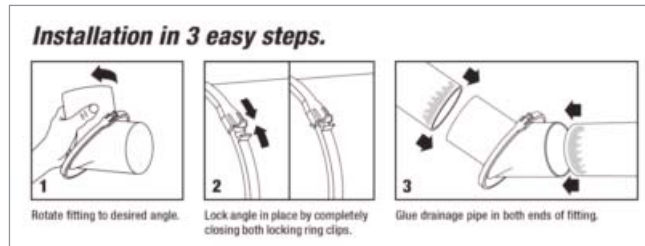

Part Number	Description	Ctn Qty
4PVAF	Swivel Fit Fitting	12

Drainage Emitter

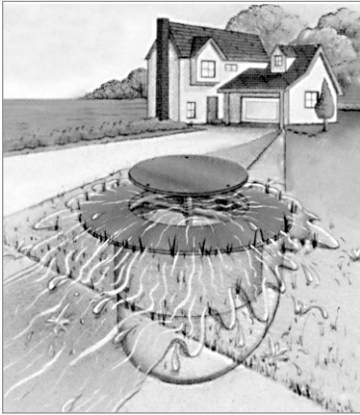

The Pop-Up Drainage Emitter is an easy, safe & efficient solution.

It allows water to be diverted and released to water-safe areas away from structures, erosion-prone landscapes and poor drainage areas.

- It allows water captured by grates, catch basins, channel drains, downspouts and roof gutter systems to flow through the drainage pipe and away from structural foundations to safe or useful areas. For example, water can be routed from a low area next to a foundation to a water safe area such as a curb-side drainage system.
- It is opened by the hydrostatic pressure of water flowing through the drain pipe. As flow diminishes the emitter closes again. The special patented design allows the emitter to open with a negligible amount of pressure. Since the emitter is closed during dry weather, debris and rodents cannot enter the drain pipes.
- It does not rise high enough to interfere with mowers.
- It blends into the surrounding landscapes.

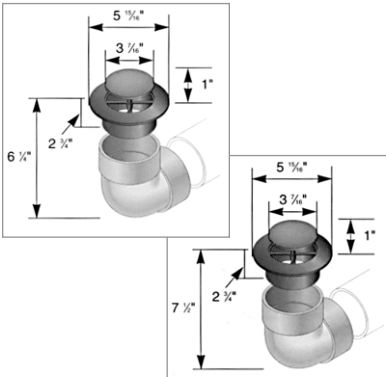

3" and 4" Emitter

- 3" and 4" PVC pop-up drainage emitter.
- Center drive pop-up with UV inhibitor.
- PVC 90° elbow with 1/4" drain hole.

Part Number	Description	Color	Weight lbs.	Ctn Qty
321	3" emitter with elbow	Green	0.60	25
421	4" emitter with elbow	Green	0.85	20

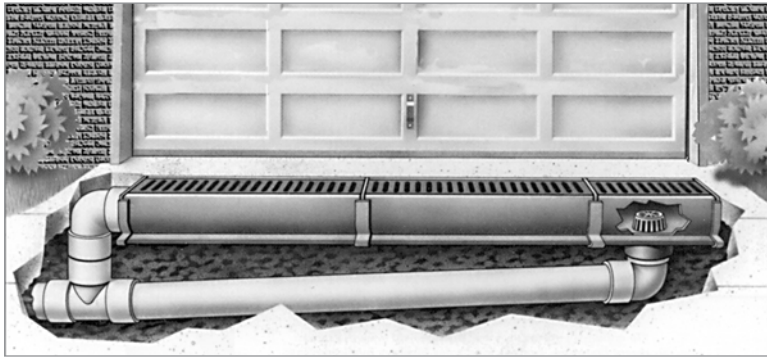

Durable

Designed for maximum durability and drainage, NDS channel drains are a proven alternative to traditional concrete drains. UV inhibitors in the grates, channels and component parts prevent fading and cracking from the sun. All plastic grate and channel components are chemically resistant, rust proof and maintenance free.

Simple

NDS channel is light-weight and easy to install. Grates are removable for easy clean-out and replacement. Channel grates may be held in place with NDS screws or hold down clips. A complete line of accessories is available for each channel.

NDS channel systems operate on the same principle as a roof gutter. All NDS channel easily connects to sewer and drain pipe and fittings or Sch 40 pipe and fittings.

Versatile

To blend with surrounding surfaces, channel grates are available in six colors. The channel system also offers a choice of outlets. Water can be evacuated from the bottom of the channel or from the end or sides of the channel.

Efficient

Channel drain eliminates the need for grading a deck surface to a low area. Instead, the deck is gradually sloped in one direction or plane, and the channel drain acts as a perimeter drain at the edge of the slope. Most hardscapes experience more runoff than landscapes due to the lack of water absorption. Channel drain systems provide more overall surface area than conventional area grates.

Non-Sloped Channel System Advantages

NDS offers non-sloped channel system advantages; less expensive, simplifies inventory, eliminates need to stock various sloping channel sections. Multiple outlets provide safety through redundancy, should any individual outlet become clogged. Proper flow is assured by use of sloped drain pipe.

Recommended Applications

- Driveways
- Parking Lots
- Warehouses
- Swimming pools & spas
- Washdown areas
- Tennis Courts
- Sidewalks
- Patios
- Sports Facilities
- Nurseries & greenhouses

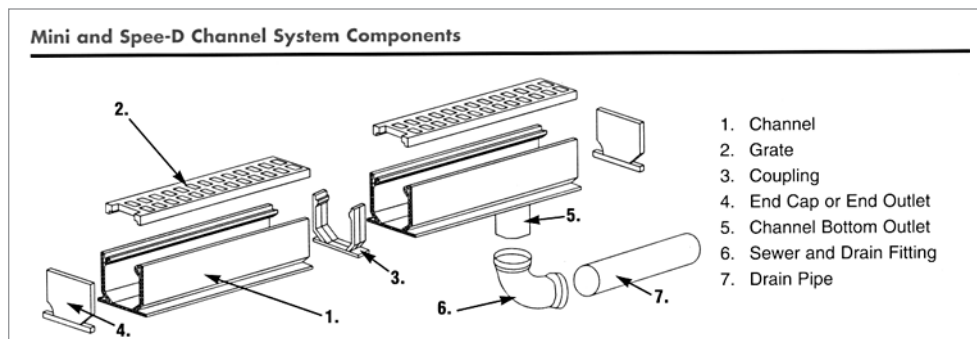

Channel Drains



Installation:

1. Standard Installation

Excavate a trench to accommodate the channel and bedding concrete. Erect a string line at each end of the drain run as a guide for laying the channels to the required level. Begin channel installation at the evacuation or discharge end of the run where the outlet or outlets are located.

Install channel end-to-end PVC cementing sections together. Design bottom or end outlets into the channel run in the appropriate location and glue to the drain pipe or fittings. PVC cement end caps where appropriate.

Using either NDS stakes, 1/2" or 5/8" rebar or wood stakes, anchor channel to the trench bed every 24" on each side of channel. Backfill with either concrete, sand or soil depending on the application. Pour slab to grade and finish concrete.

Figure 1A illustrates a light vehicular installation in which a concrete base may not be required. Compacted soil and a 1" sand base may be used in place of concrete.

Figure 1B illustrates a concrete base underneath the channel recommended for heavy load applications or freeze/thaw zones where heaving may be a problem.

2. Suspended Installation

Suspended installation is ideal for retrofit installations with an existing concrete slab or new construction where forms can be used to suspend the channels. Prepare the trench excavation. Using 2" x 4" boards, span the width of the trench and bolt the channel grates to the boards. Pour and compact concrete under and around the channels. Finish to the proper grade. Figure 2.

3. Slurry Installation

This installation may be used in lieu of the standard installation. Prepare the trench excavation and pull a stringline to the proper elevation. Pour a slurry of concrete in the trench to a depth that will insure at least 4" of concrete underneath the channels. Lay the channels in the bedding slurry. Check the channel alignment and grade again. After the slurry sets, concrete can be poured around the channel and finished to the proper grade. Figure 3.

Notes:

1. Grate must be installed prior to pouring concrete or backfill.
2. Grate should be recessed 1/8" below finish grade in non traffic applications. Grate should be recessed 1/4" in traffic applications.
3. In asphalt or hot mastic applications, the channels must be encased in concrete for strength and to prevent distortion of the channel.
4. Grates should be taped prior to pouring concrete to prevent debris from entering channel during installation.
5. Refer to load classification chart for proper application.
6. Expansion joints must be provided parallel, but not immediately adjacent to each side of the drain run and crack control joints utilized at right angles to the channel for installation in concrete.
7. PVC primer and medium body fast set PVC solvent cement must be used to cement all components.
8. Grate must be installed on channel at all times except for cleaning.

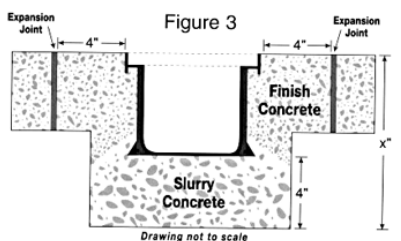
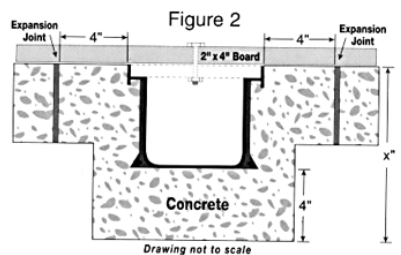
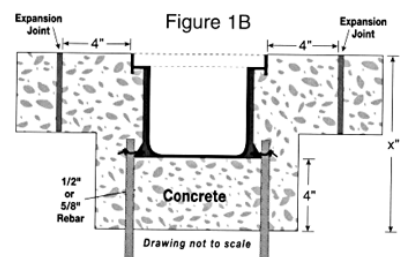
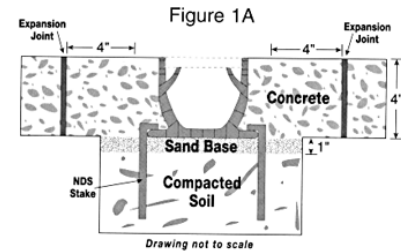



Mini Channel™ Drains



Mini Channel™ Drain Features:

- Patented
- Low-cost alternative to Spee-D Channel.
- Excellent for light duty applications including residential pools, patios, spas and tennis courts.

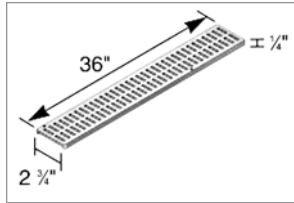

3' Channel Grate

- Structural foam polyolefin channel grate with UV inhibitors.
- Open surface area 11.3 sq. in.. 14.8 gpm per foot.
- 1/4" x 5/16" grate opening.
- Requires 4 screws per grate.



Part Number	Description	Color	Weight lbs.	Ctn Qty
541	3' channel grate	Gray	0.688	48 ft
542	3' channel grate	Green	0.688	48 ft
543	3' channel grate	Black	0.688	48 ft
544	3' channel grate	Sand	0.688	48 ft
551	3' channel grate	Brick Red	0.688	48 ft

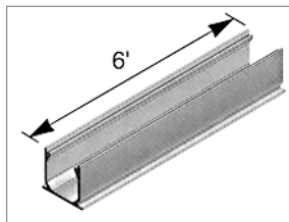

6' Mini Channel Drain

- 6' PVC Mini channel drain with inverse flying buttress design, bottom flange, patented honeycomb reinforced walls and UV inhibitor.
- Grates should be recessed 1/8" below finish grade in non traffic applications. Grate should be recessed 1/4" in traffic applications.

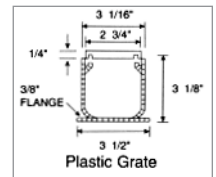

Part Number	Description	Color	Weight lbs.	Ctn Qty
500-6	6' Mini Channel Drain	Gray	4.00	48 ft

Mini Channel™ Drain Accessories:

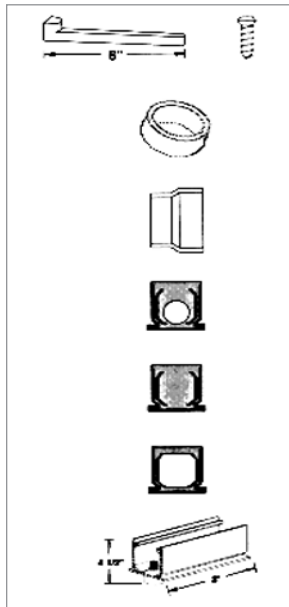

Part Number	Description	Color	Weight lbs.	Ctn Qty
529	Stainless Steel Screws type FH-#4 x 3/8"	Steel	0.10	64
230	6" channel installation stake	Gray	0.40	24
532	2" Sch 40 hub to 3" S&D spigot adapter	White	0.20	20
533	2" Sch 40 hub to 4" S&D spigot adapter	White	0.35	20
546	Spigot end outlet for 2" Sch. 40 pipe	Gray	0.30	10
547	3" Channel end cap	Gray	0.15	20
548	3" Channel Coupling	Gray	0.20	20
550	3' channel w/ 2" Sch 40 spg bottom outlet	Gray	2.17	6

AGI has access to the complete line of NDS drainage products. Contact customer sales for more information and pricing.



www.cbsupplies.ca
 Phone: (866) 503-5523 Fax: (888) 562-2095
 AGI@cbsupplies.ca



Mini Channel™ Drains

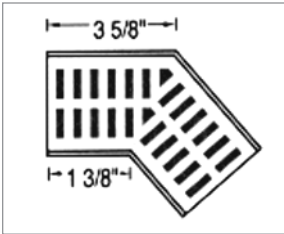

Fabricated 45° Elbow with Grate

Part Number	Description	Color	Weight lbs.	Ctn Qty
5300	Fabricated 45° elbow w/ grate	Gray	0.40	1
5301 ☺	Fabricated 45° elbow w/ grate	Green	0.40	1
5302 ☺	Fabricated 45° elbow w/ grate	Black	0.40	1
5303 ☺	Fabricated 45° elbow w/ grate	Sand	0.40	1
5304 ☺	Fabricated 45° elbow w/ grate	Brick Red	0.40	1

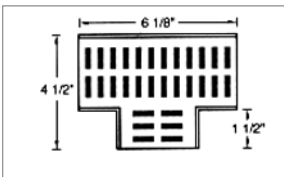

Fabricated Tee with Grate

Part Number	Description	Color	Weight lbs.	Ctn Qty
5370	Fabricated tee w/ grate	Gray	0.50	1
5371 ☺	Fabricated tee w/ grate	Green	0.50	1
5372 ☺	Fabricated tee w/ grate	Black	0.50	1
5374 ☺	Fabricated tee w/ grate	Brick Red	0.50	1

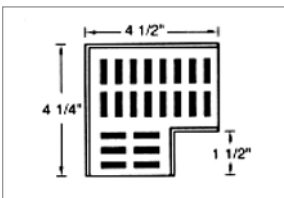

Fabricated 90° Elbow with Grate

Part Number	Description	Color	Weight lbs.	Ctn Qty
5380	Fabricated 90° elbow w/ grate	Gray	0.40	1
5383 ☺	Fabricated 90° elbow w/ grate	Sand	0.40	1
5384 ☺	Fabricated 90° elbow w/ grate	Brick Red	0.40	1

☺ Non-stock item, available on a special order basis.

AGI has access to the complete line of NDS drainage products. Contact customer sales for more information and pricing.



www.cb-supplies.ca
 Phone: (866) 503-5523 Fax: (888) 562-2095
AGI@cb-supplies.ca





Spee-D Channel™ Drains



Spee-D Channel™ Drain Features:

- Patented.
- Ideal for commercial as well as residential applications.
- Effective in everything from patios to light vehicular traffic areas.

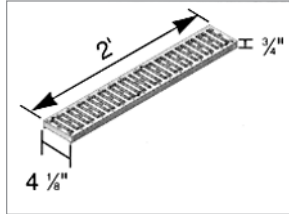

2' Channel Grate

- 2' Structural foam polyolefin secured channel grate with UV inhibitors.
- Open surface area 19.3 sq. in..
- 3/8" x 3 1/4" grate opening.
- Requires 4 screws per grate.



Part Number	Description	Color	Weight lbs.	Ctn Qty
241	2' channel grate	Gray	1.42	24 ft
242	2' channel grate	Green	1.42	24 ft
243	2' channel grate	Black	1.42	24 ft
244	2' channel grate	Sand	1.42	24 ft
251	2' channel grate	Brick Red	1.42	24 ft

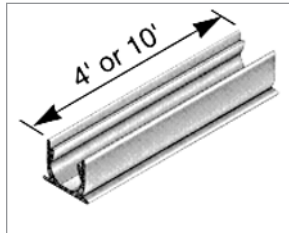

4' Channel Drain

- 4' PVC Spee-D channel drain with inverse flying butress design, bottom flange, patented honeycomb reinforced walls and UV inhibitor.
- Grate should be recessed 1/8" below finish grade in non traffic applications. Grate should be recessed 1/4" in traffic applications.
- 10' Length ships via truck only.

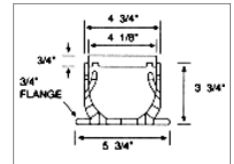

Part Number	Description	Color	Weight lbs.	Ctn Qty
400	4' Channel Drain	Gray	4.83	24 ft
400-10	10' Channel Drain *	Gray	1.10	60 ft

Spee-D Channel™ Drain Accessories:

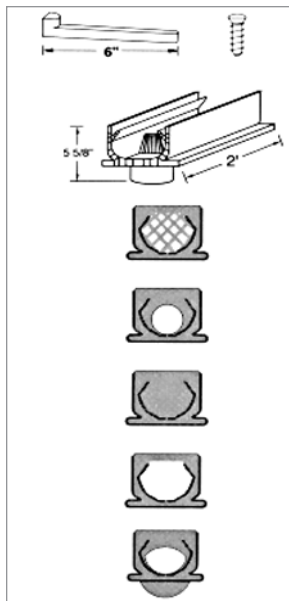

Part Number	Description	Color	Weight lbs.	Ctn Qty
229	Stainless Steel Screws	Steel	0.06	48
230	6" channel installation stake	Gray	0.40	24
234	2' fabricated 3" & 4" spigot bottom outlet w/ strainer. Fits 3" or 4" S&D ftg. Grate not included	Gray	2.67	1
245	Channel strainer coupling	Gray	0.35	20
246	2" Sch. 40 spigot end outlet	Gray	0.40	10
247	Channel end cap	Gray	0.40	10
248	Channel Coupling	Gray	0.40	20
249	3" & 4" offset end outlet Connects to 3" S&D pipe, 4" S&D fittings	Gray	0.50	10

AGI has access to the complete line of NDS drainage products. Contact customer sales for more information and pricing.



www.cbsupplies.ca
 Phone: (866) 503-5523 Fax: (888) 562-2095
 AGI@cbsupplies.ca



Spee-D Channel™ Drains

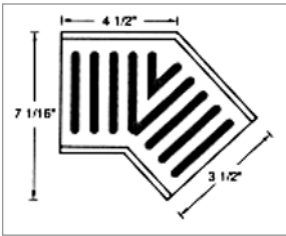

Fabricated 45° Elbow with Grate

Part Number	Description	Color	Weight lbs.	Ctn Qty
2301	Fabricated 45° elbow w/ grate	Gray	2.0	1
2302 ☺	Fabricated 45° elbow w/ grate	Green	2.0	1
2303 ☺	Fabricated 45° elbow w/ grate	Black	2.0	1
2305 ☺	Fabricated 45° elbow w/ grate	Brick Red	2.0	1

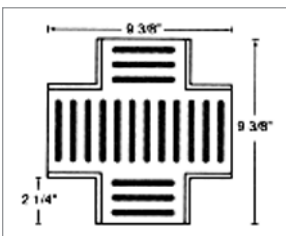

Fabricated Cross with Grate

Part Number	Description	Color	Weight lbs.	Ctn Qty
2361	Fabricated cross w/ grate	Gray	3.0	1
2362 ☺	Fabricated cross w/ grate	Green	3.0	1
2364 ☺	Fabricated cross w/ grate	Sand	3.0	1
2365 ☺	Fabricated cross w/ grate	Brick Red	3.0	1

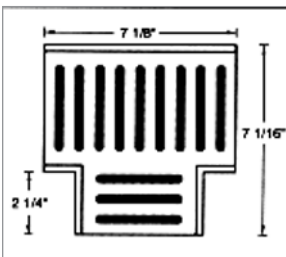

Fabricated Tee with Grate

Part Number	Description	Color	Weight lbs.	Ctn Qty
2371	Fabricated tee w/ grate	Gray	3.0	1
2372 ☺	Fabricated tee w/ grate	Green	3.0	1

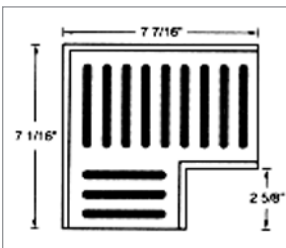

Fabricated 90° Elbow with Grate

Part Number	Description	Color	Weight lbs.	Ctn Qty
2381	Fabricated 90° elbow w/ grate	Gray	3.0	1
2382 ☺	Fabricated 90° elbow w/ grate	Green	3.0	1
2385 ☺	Fabricated 90° elbow w/ grate	Brick Red	3.0	1

☺ Non-stock item, available on a special order basis.

AGI has access to the complete line of NDS drainage products. Contact customer sales for more information and pricing.



www.cb-supplies.ca
 Phone: (866) 503-5523 Fax: (888) 562-2095
 AGI@cb-supplies.ca

